

Rodzaje Krawędzi

A
zaokrąglenie

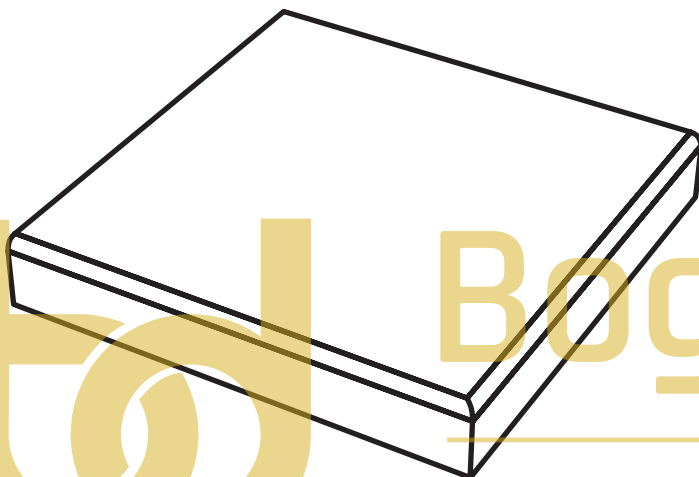

B
Faza 45 stopni

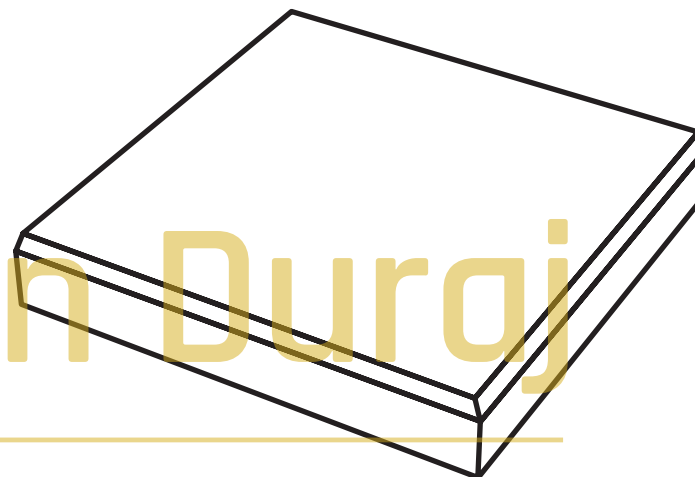

C
Faza 45 stopni +

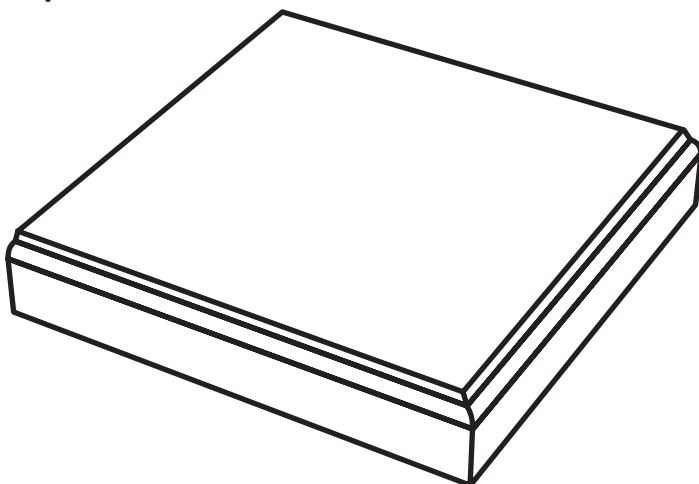

M D E B L E
2xFaza 45 stopni

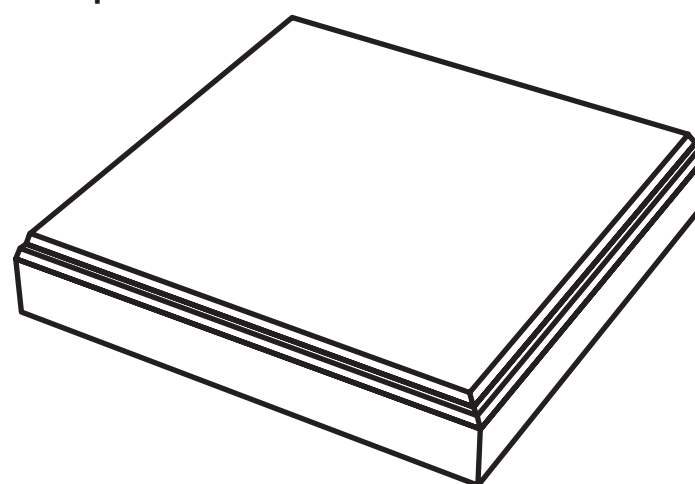

Bogdan Duraj

SE
Szpros Ekstra

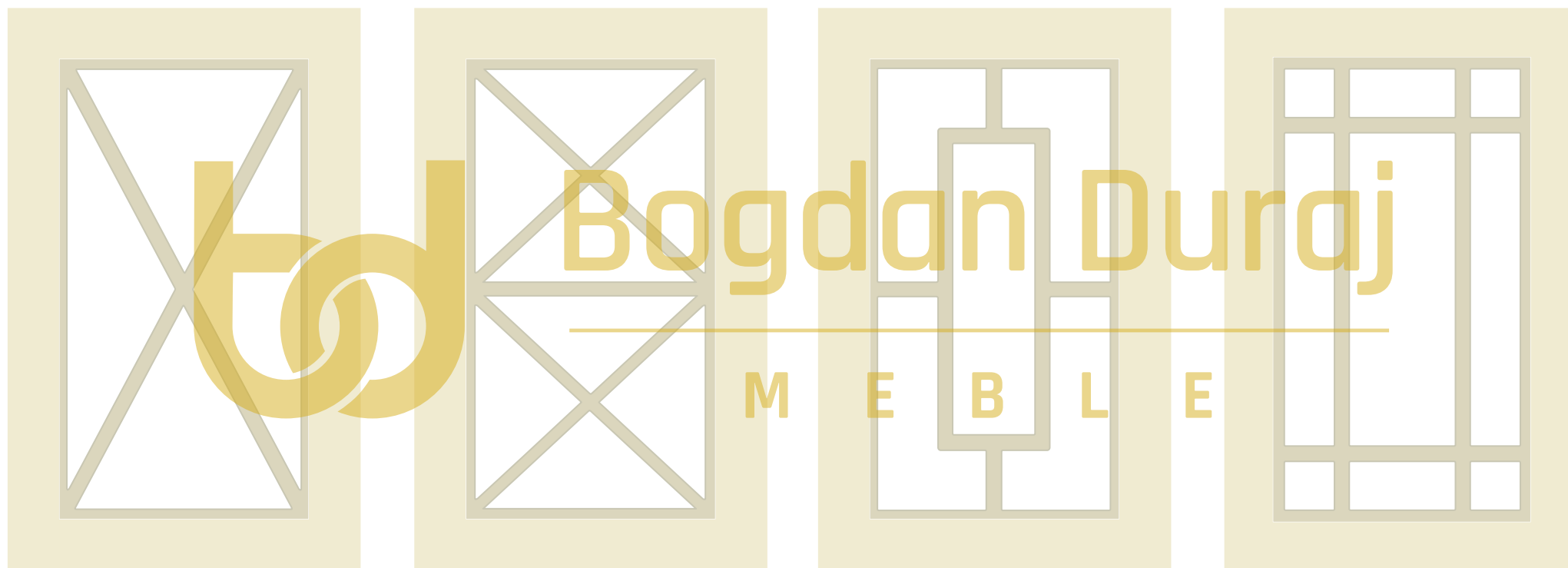

SE1

SE2

SE3

SE4

SW
Szpros Wysoki



SW1

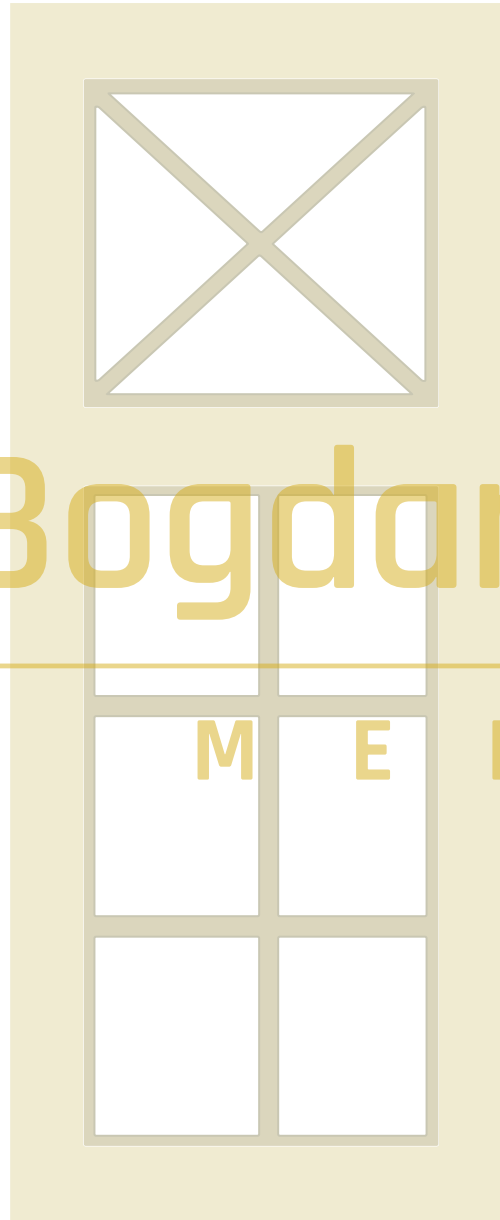

SW2

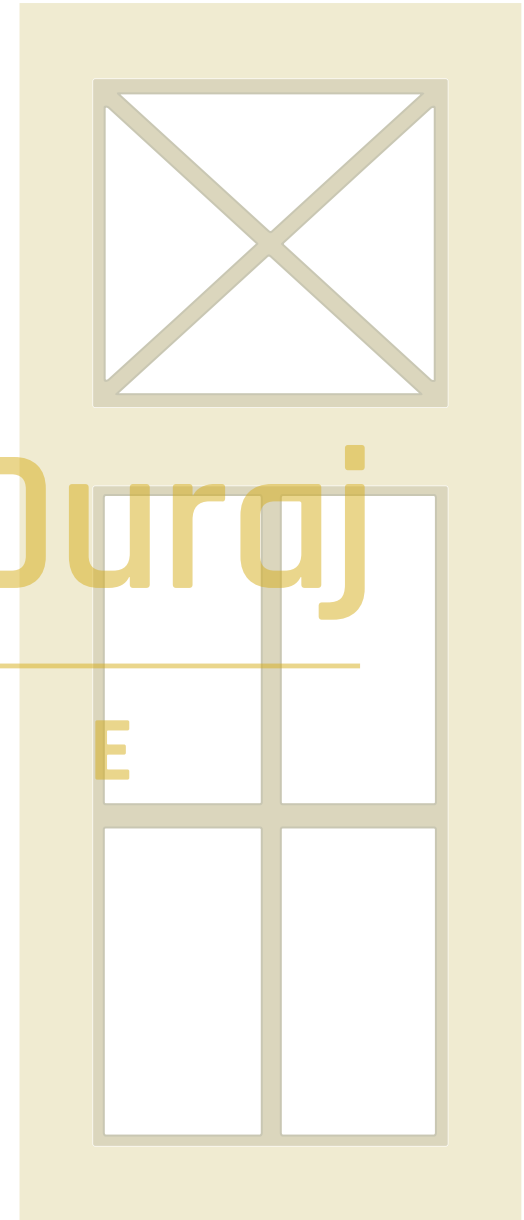

SW3

Bogdan Duraj

M E B L E

SW
SZPROS WYSOKI

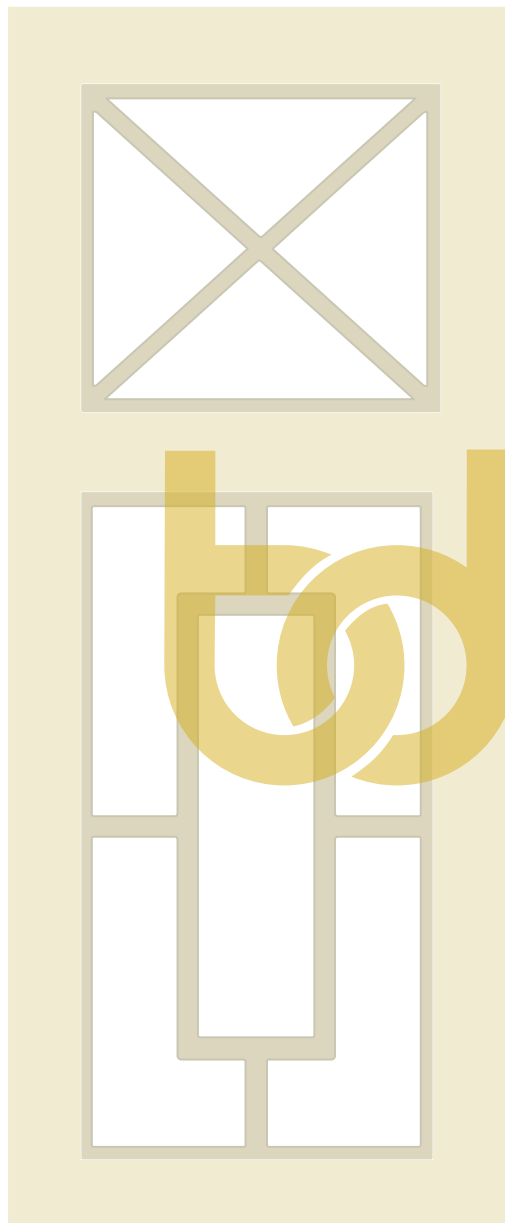

SW4



SW5

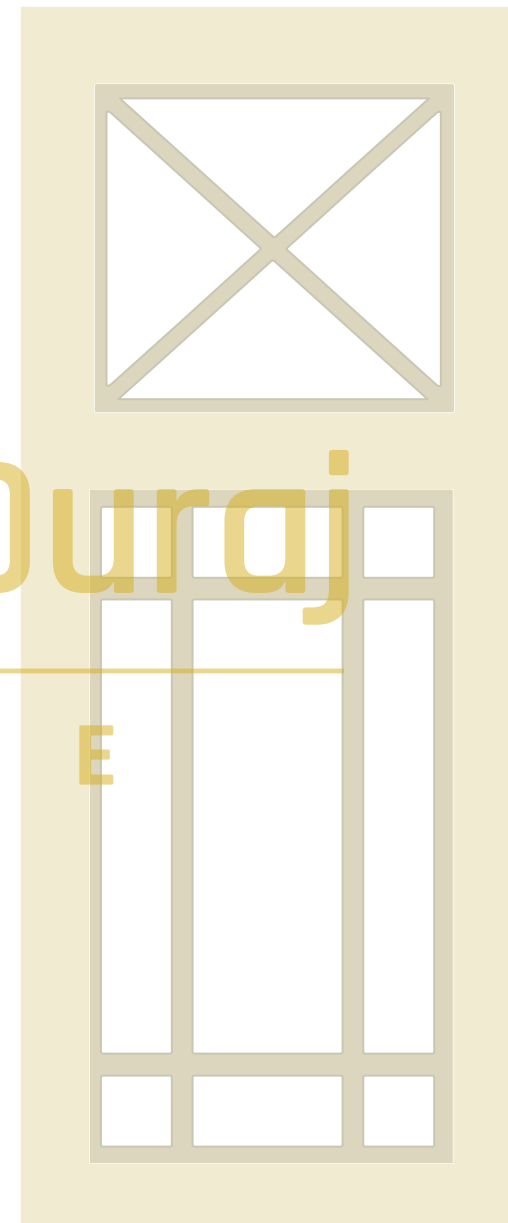

SW6



Bogdan Duraj

M E B L E

P1
Paski 1

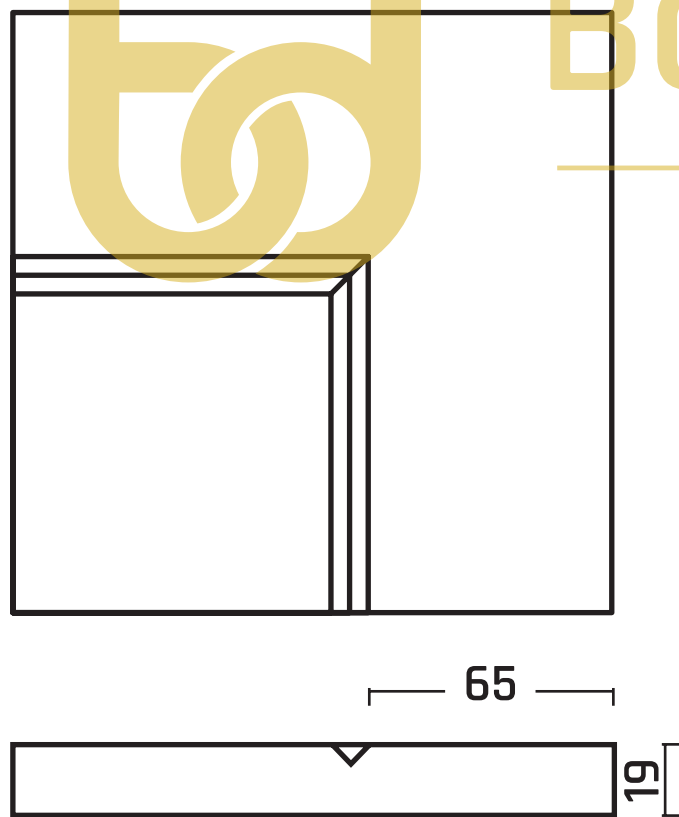
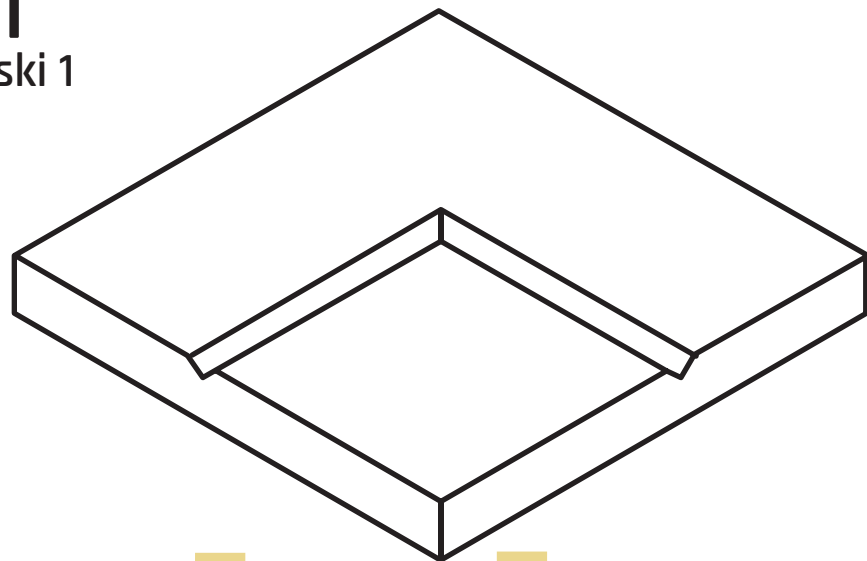

Front

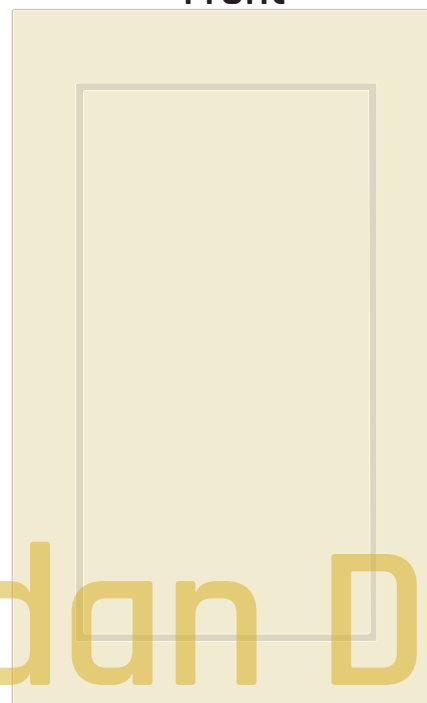

Szuflady

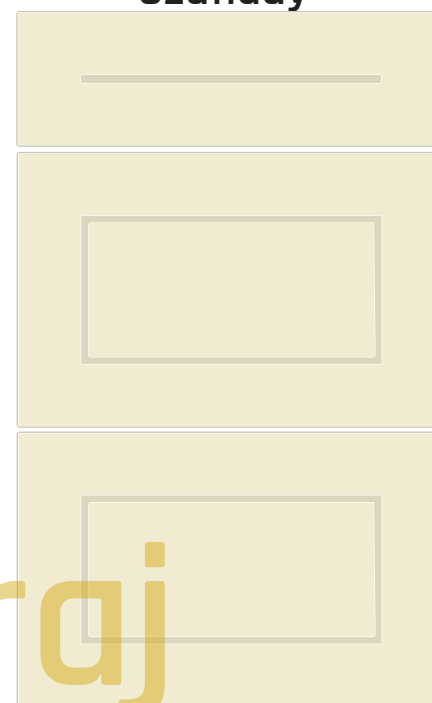

Witryna Szpros

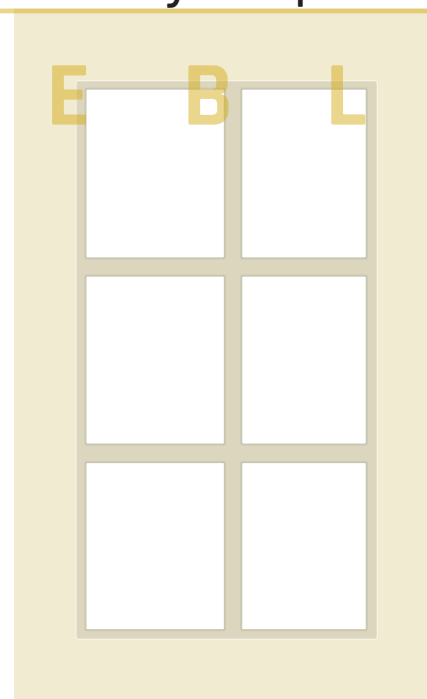

Witryna

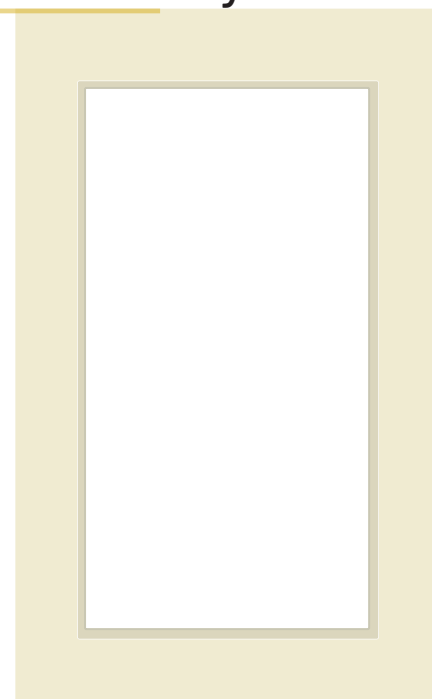

bd Bogdan Duraj

M E B L E

P3
Paski 3

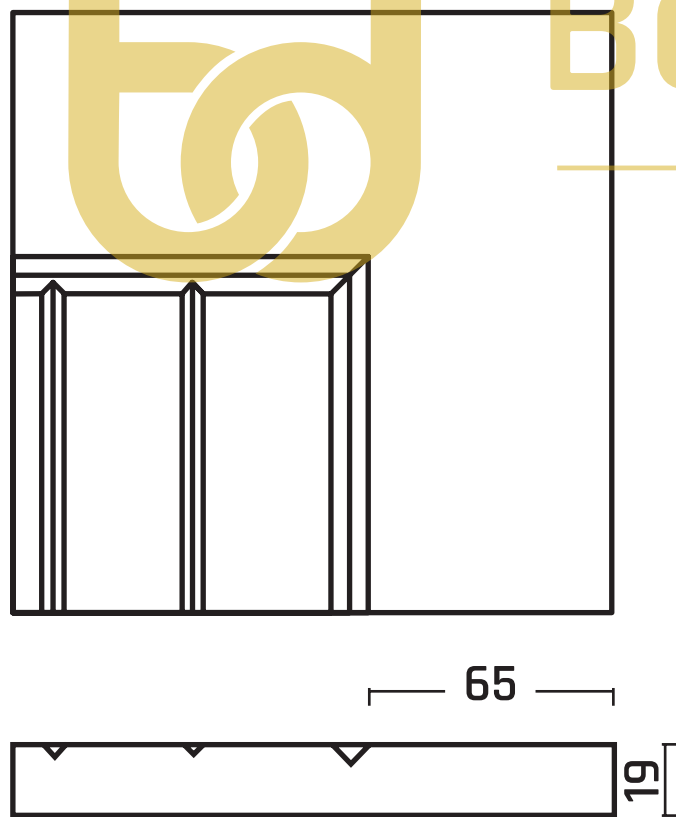
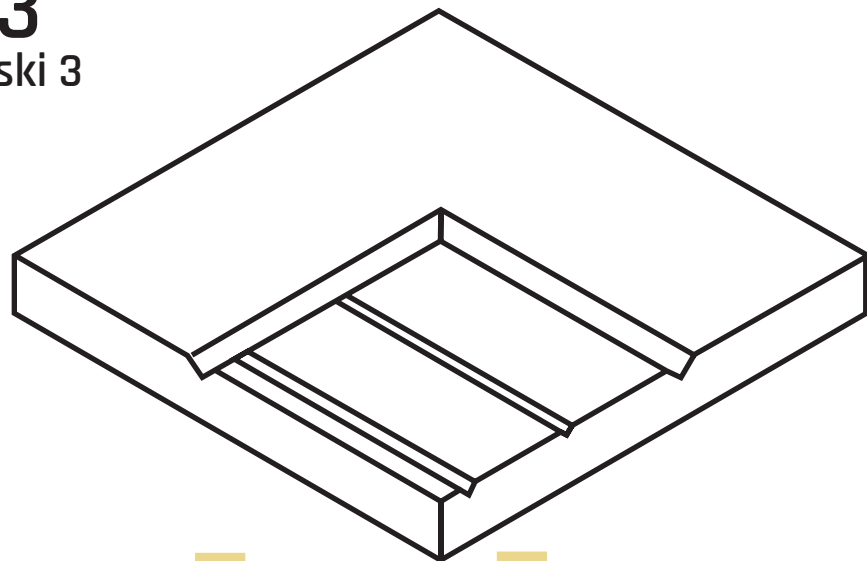

Front

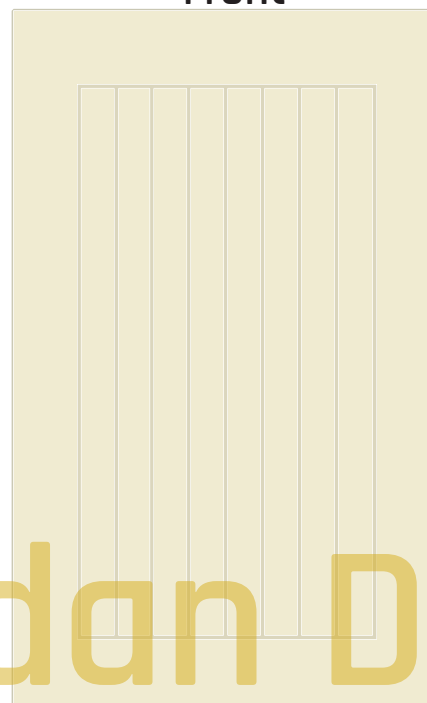

Szuflady

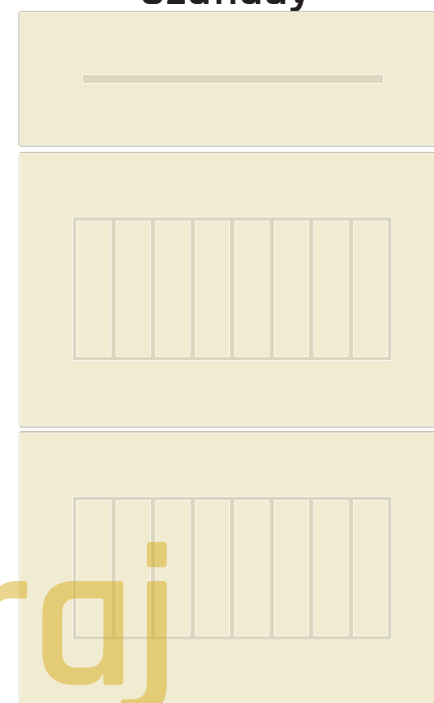

Witryna Szpros

Witryna

M E B L E

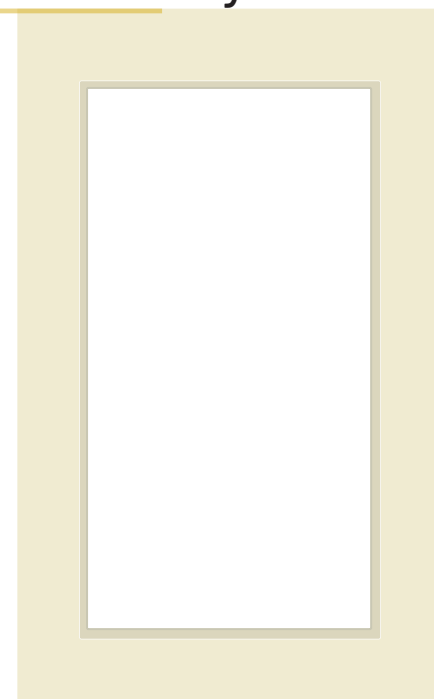
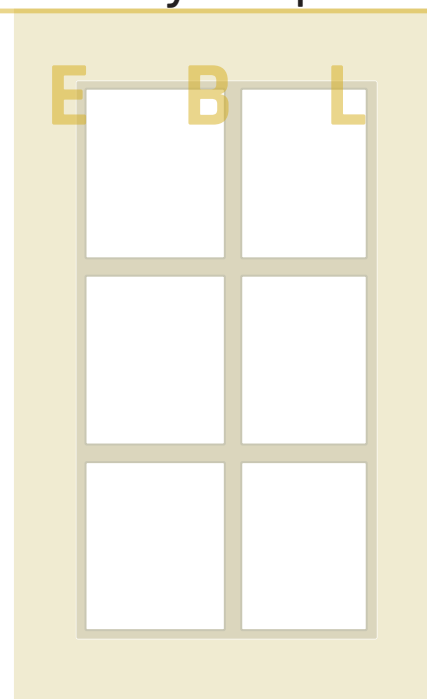

P2
Paski 2

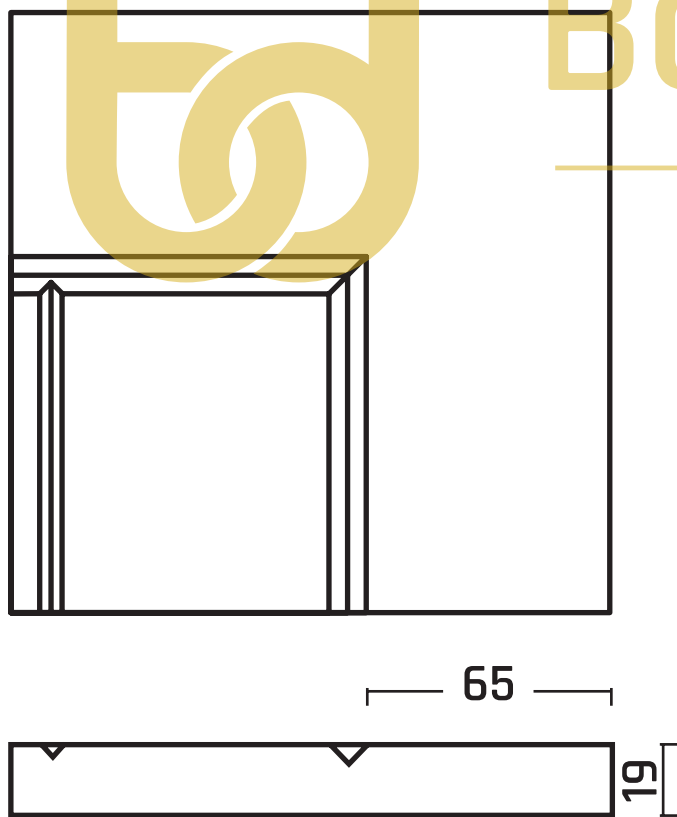
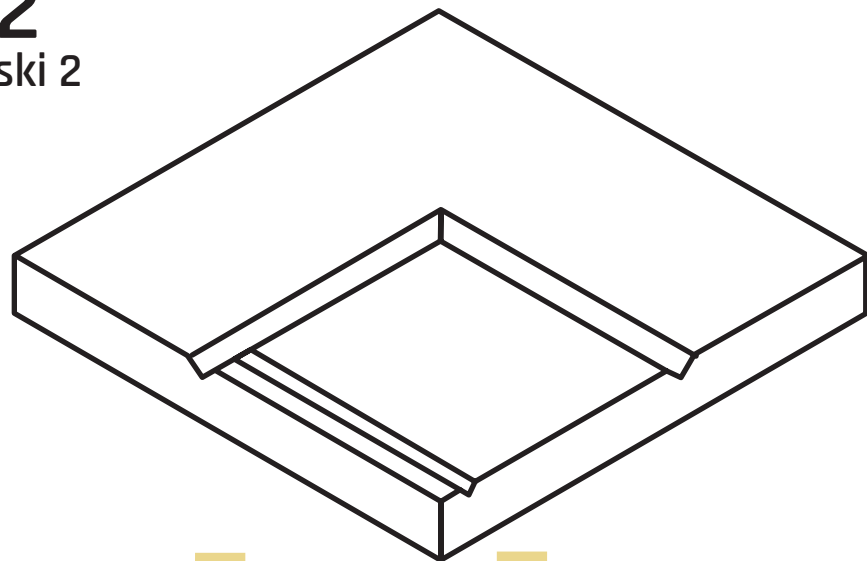

Front

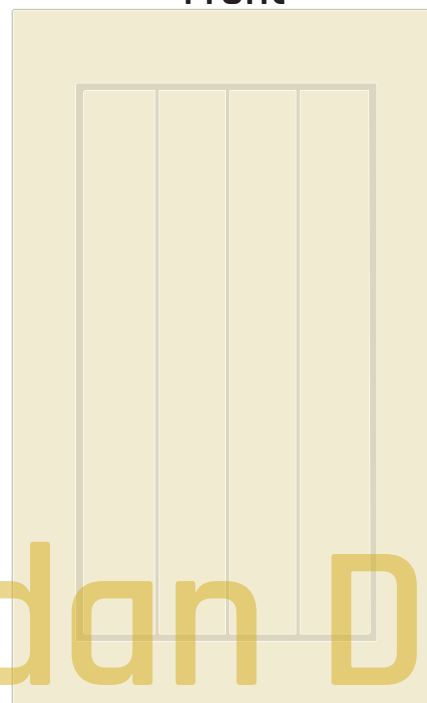

Szuflady

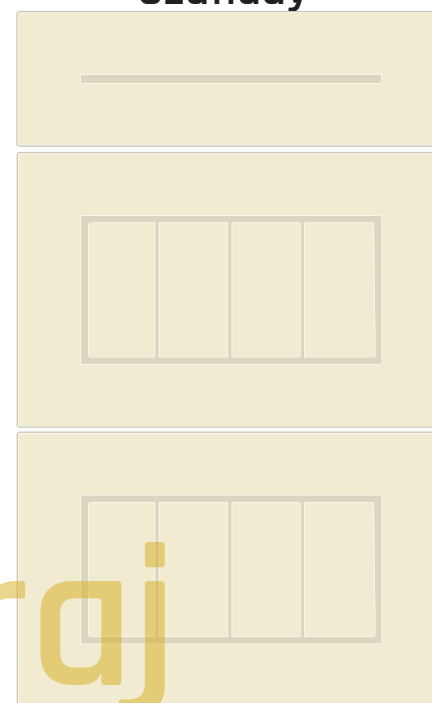

Witryna Szpros

Witryna

M E B L E

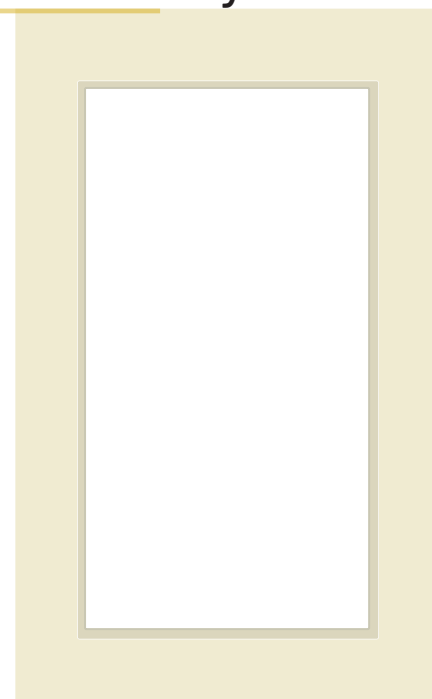
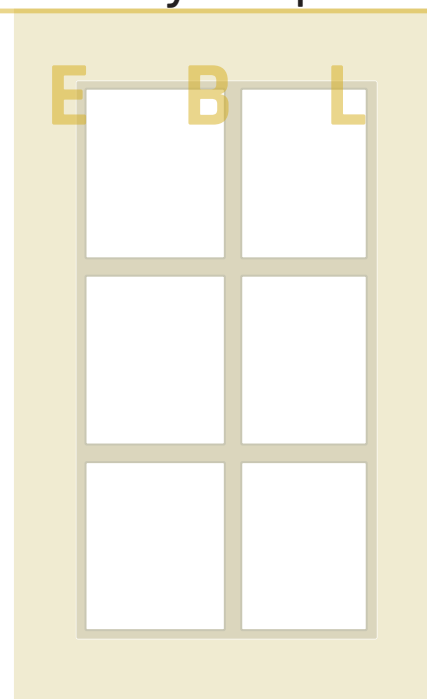

P4
Paski 4

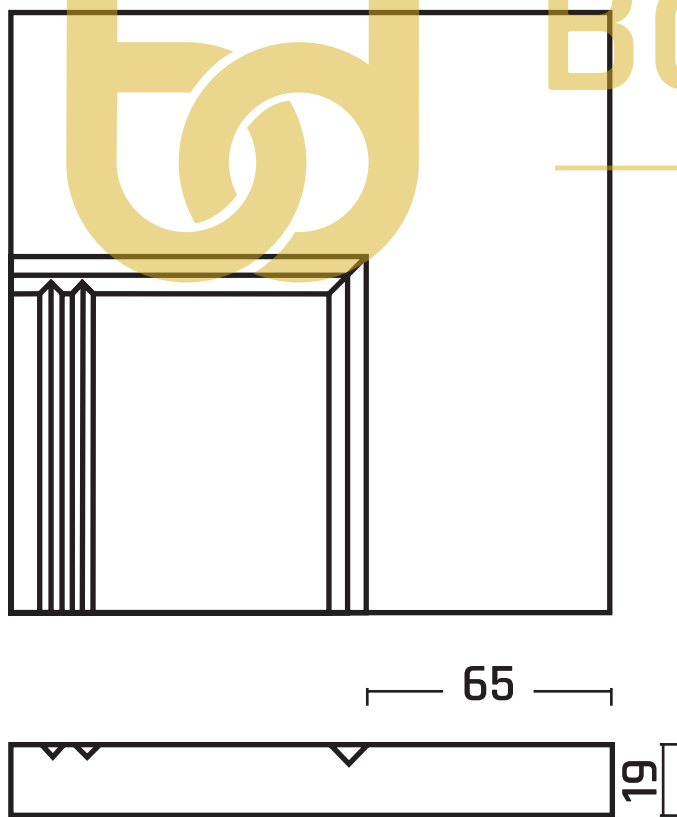
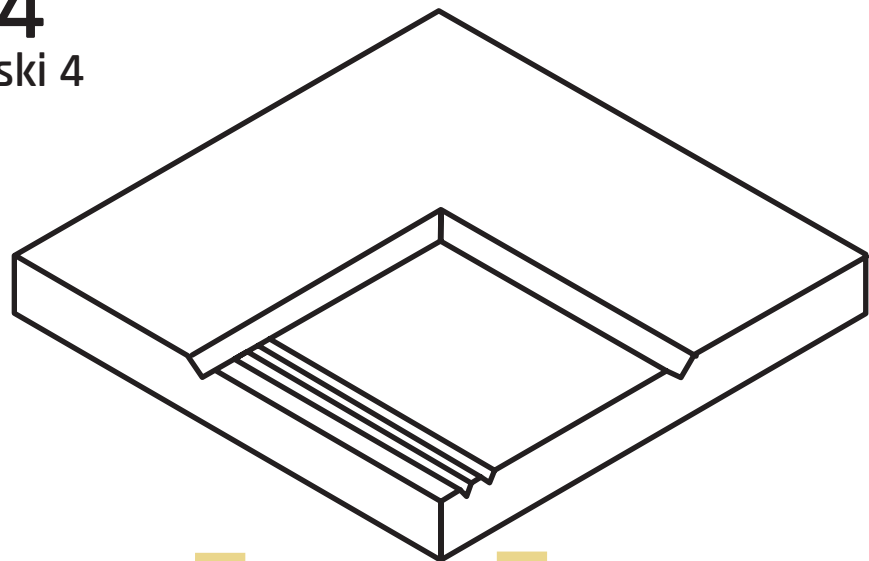

Front

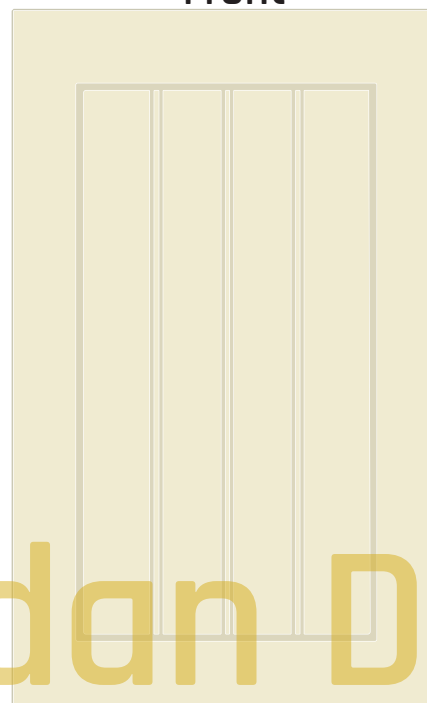

Witryna Szpros

Szuflady

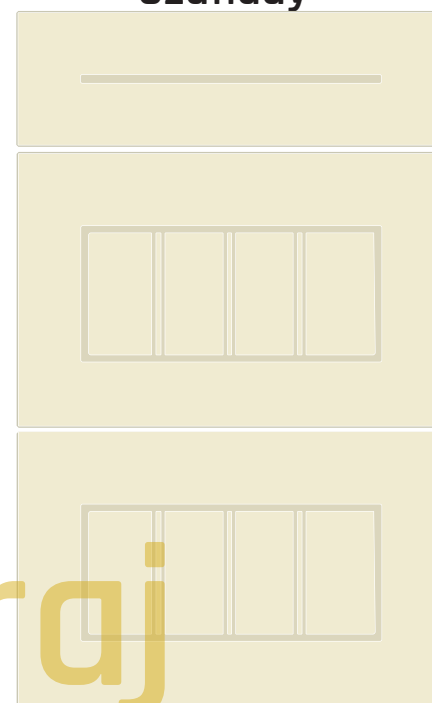

Witryna

M E B L E

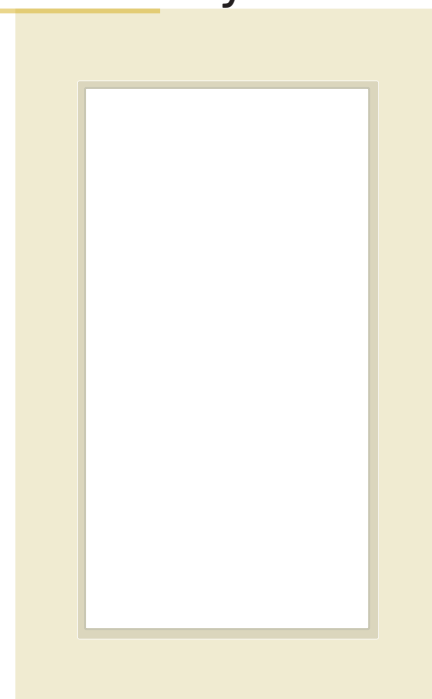
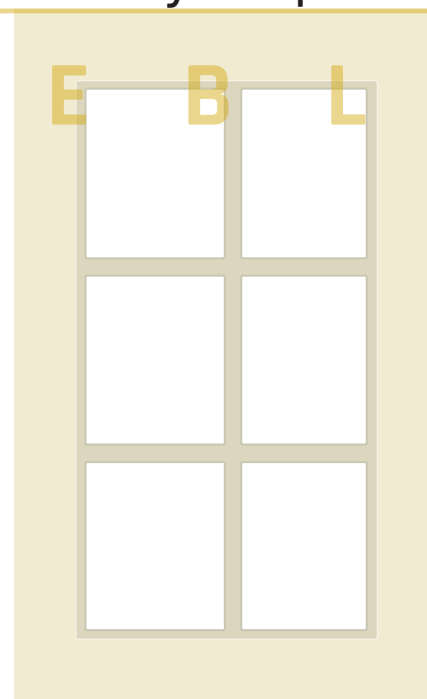

R1
Ramka 1

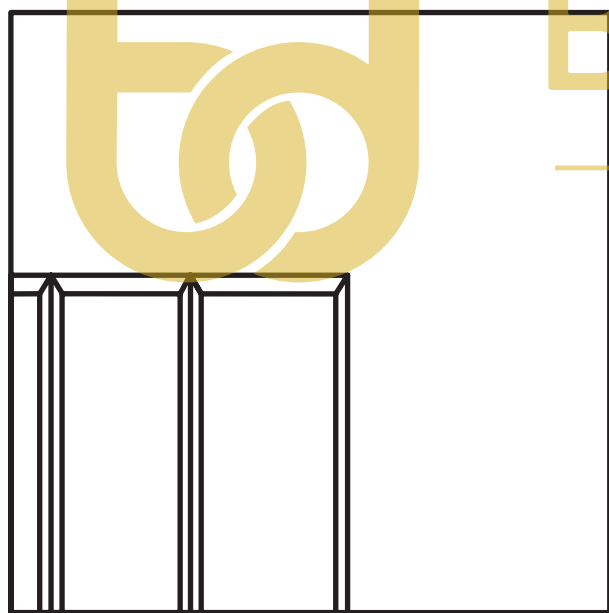
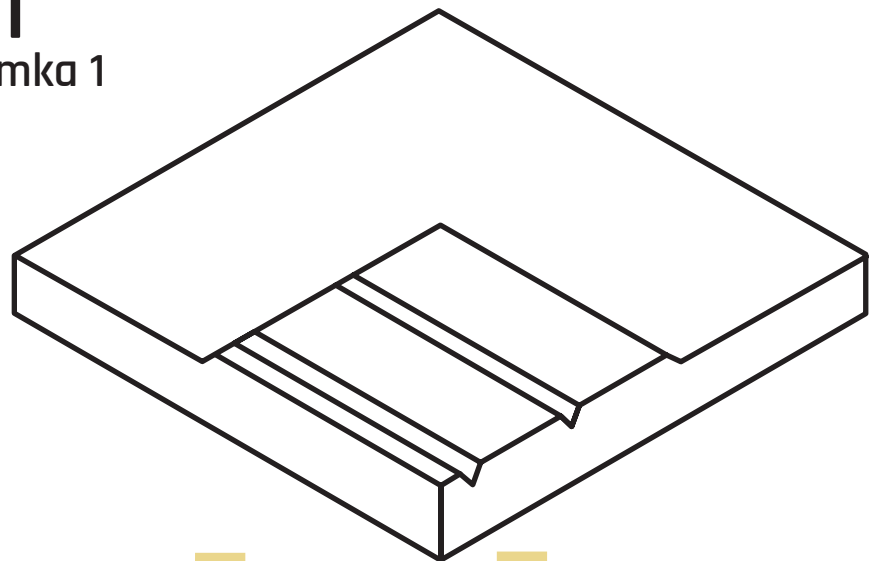

Front

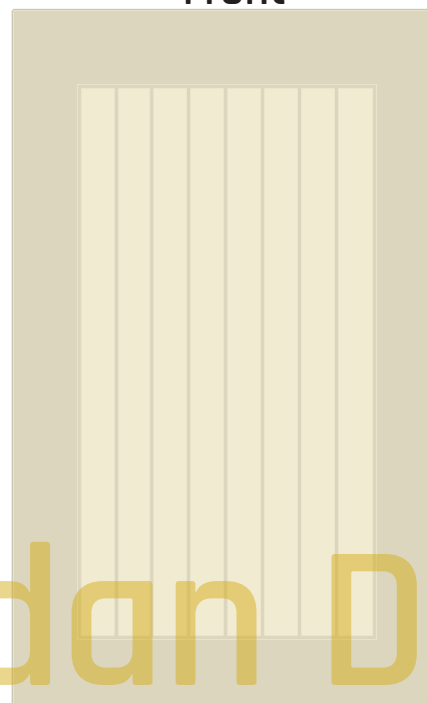

Szuflady

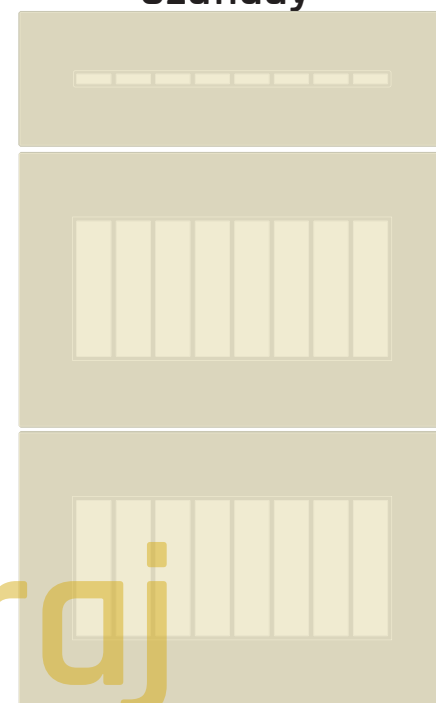

Bogdan Duraj

Witryna Szpros

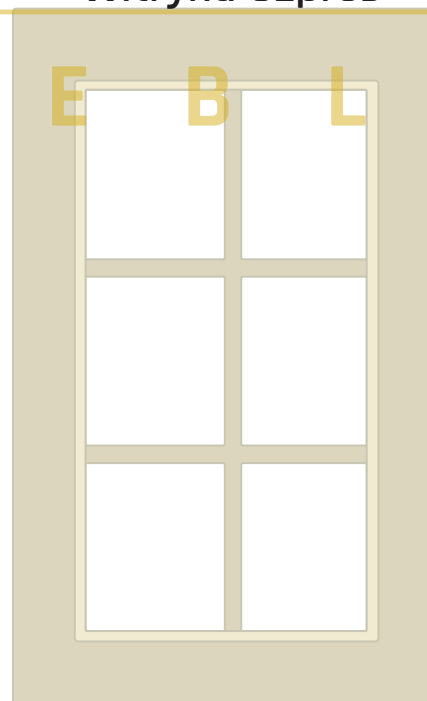

Witryna

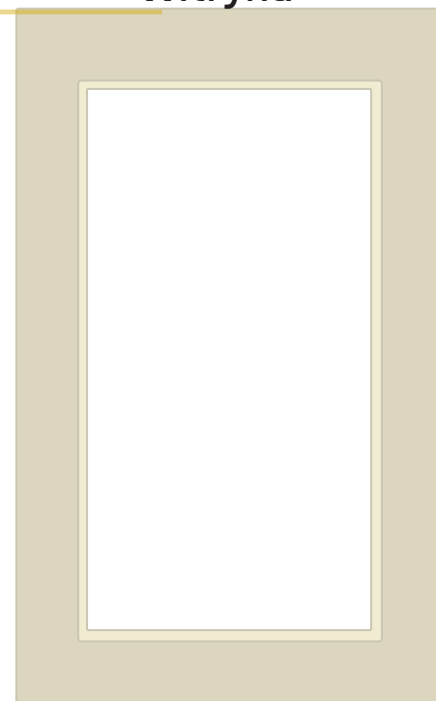

M E B L E

R2
Ramka 2

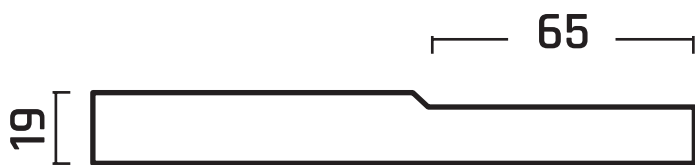
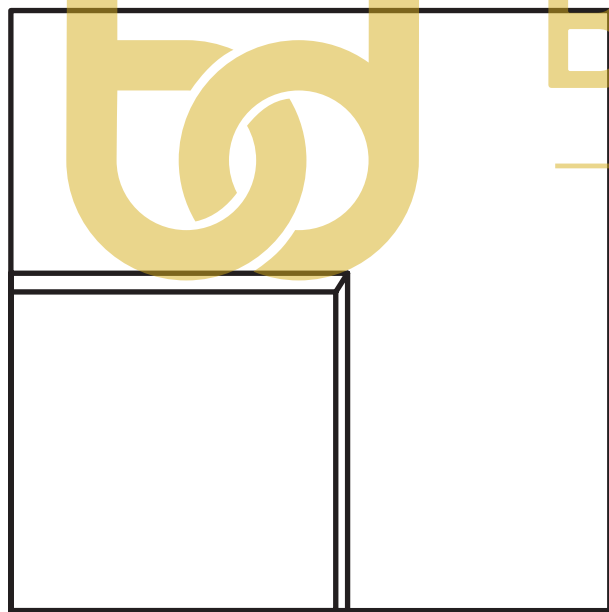
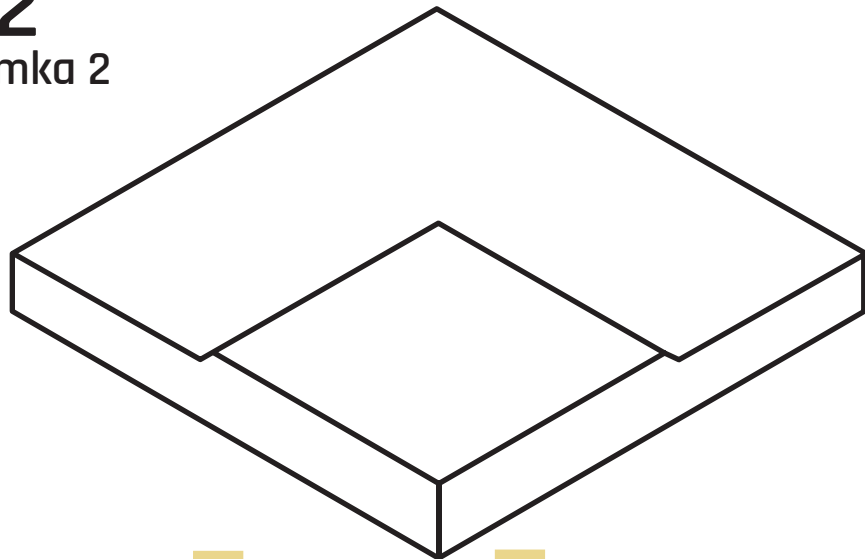

Front

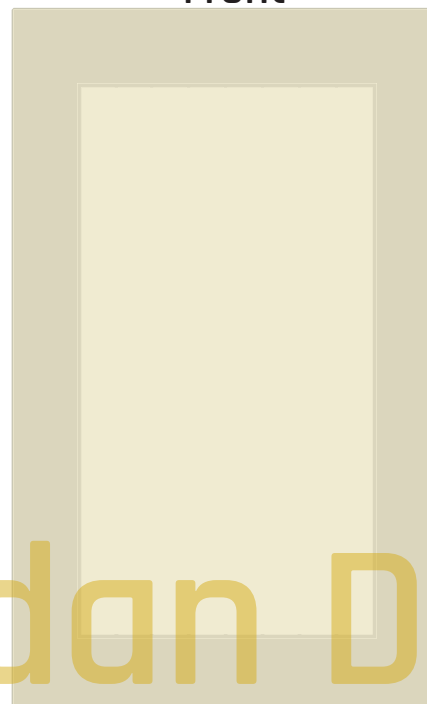

Szuflady

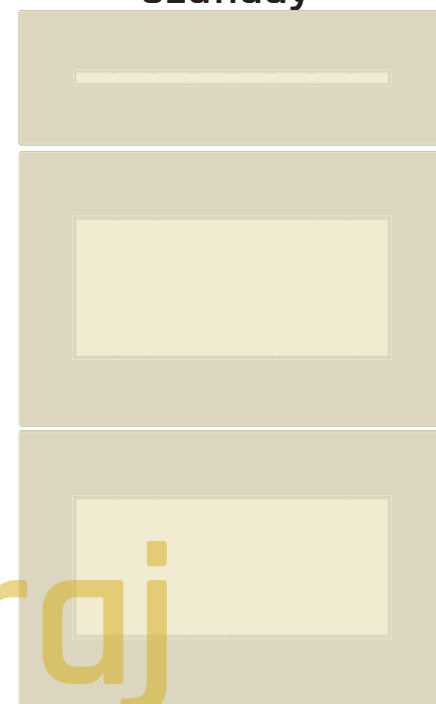

Bogdan Duraj

Witryna Szpros

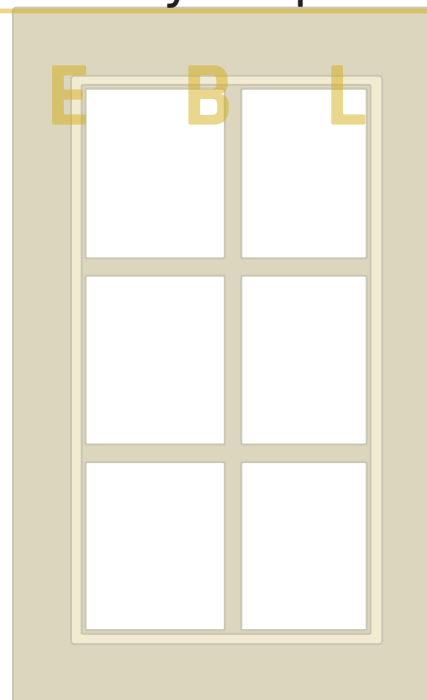

Witryna

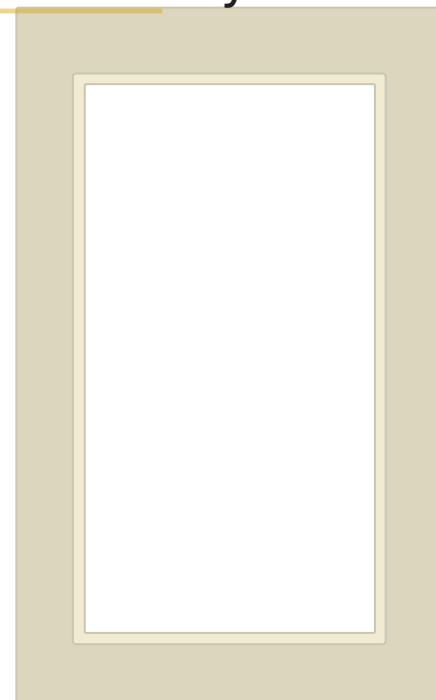

M E B L E

R3
Ramka 3

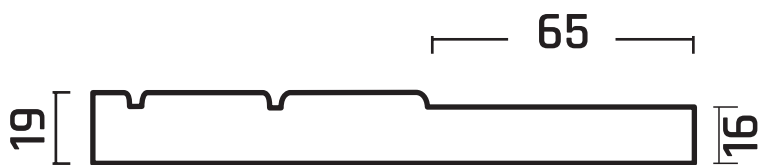
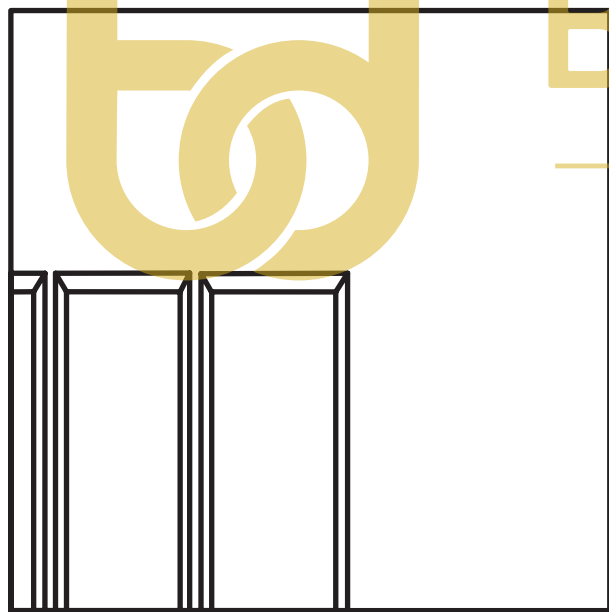
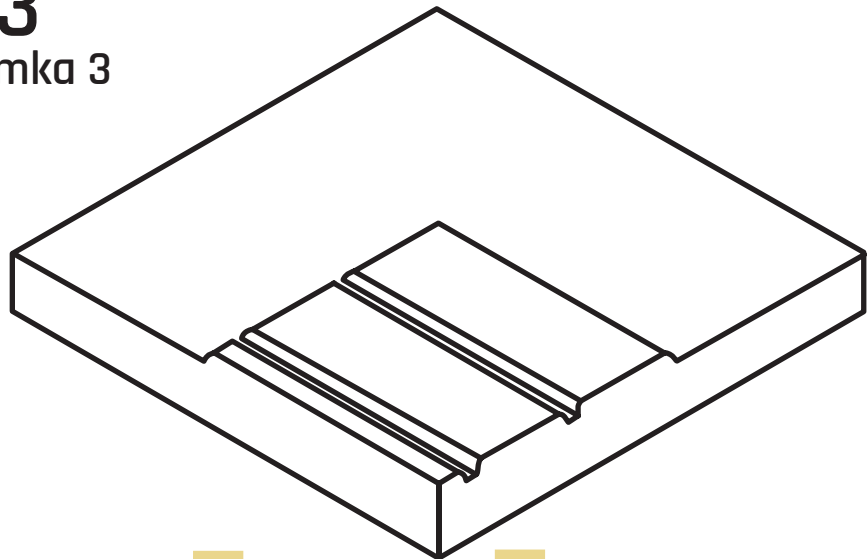

Front

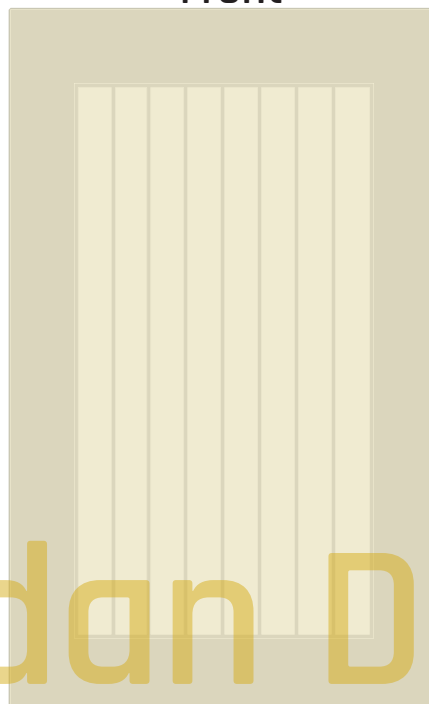

Szuflady

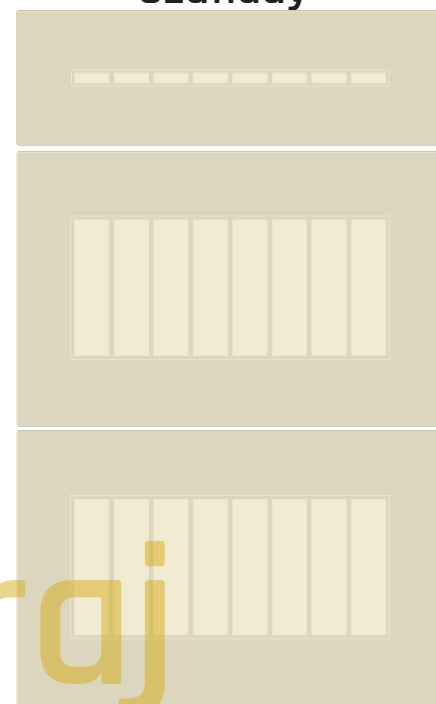

Bogdan Duraj

Witryna Szpros

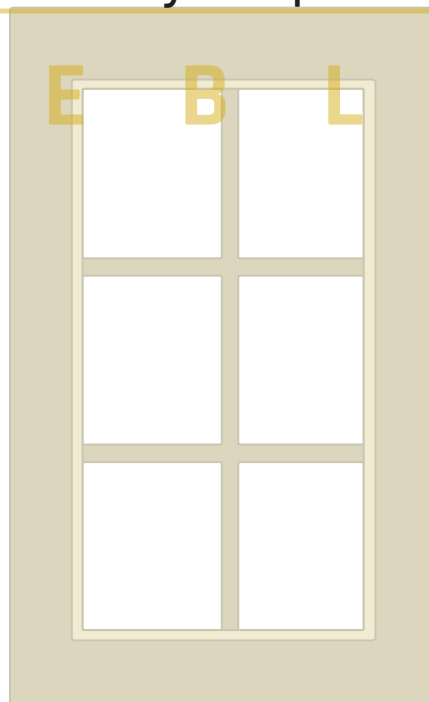

Witryna

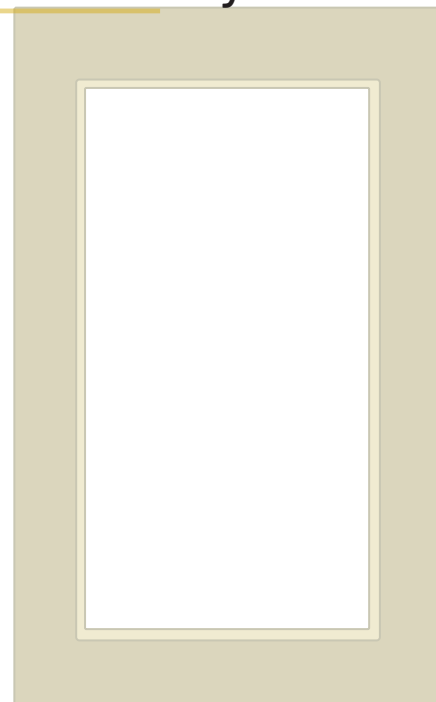

M E B L E

R4
Ramka 4

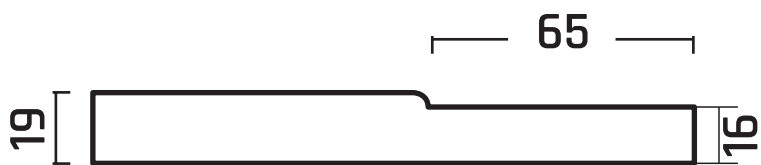
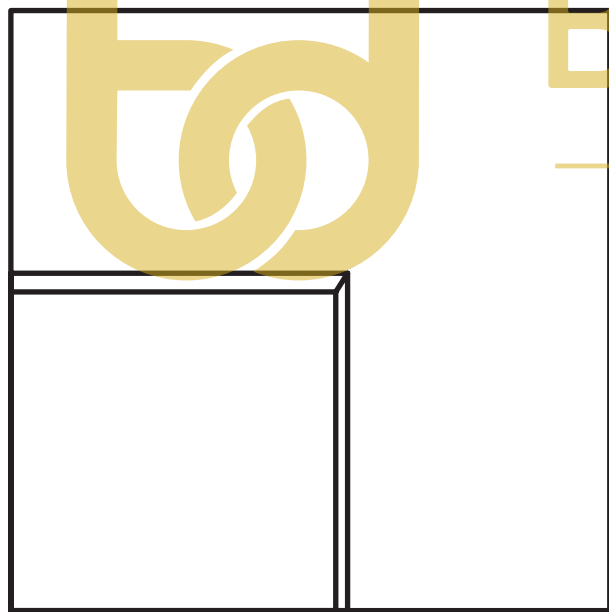
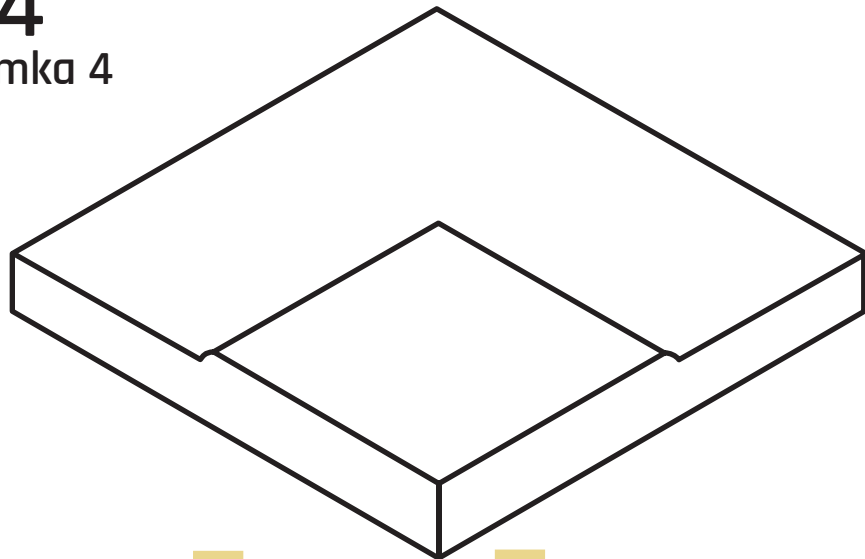

Front

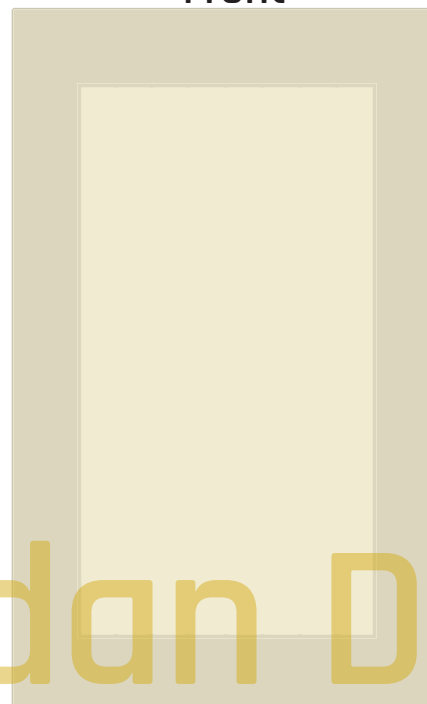

Szuflady

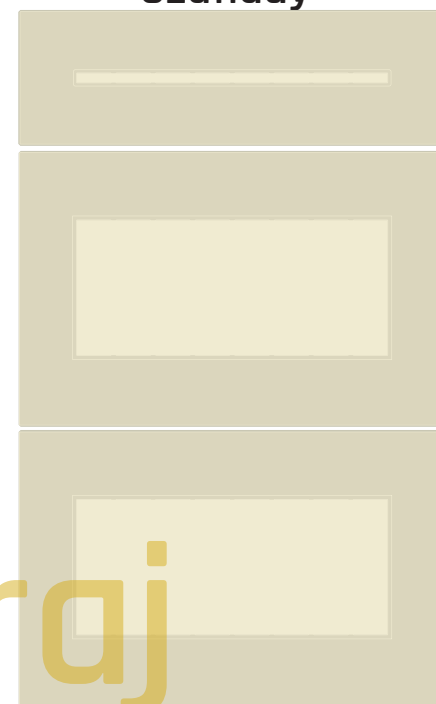

Witryna Szpros

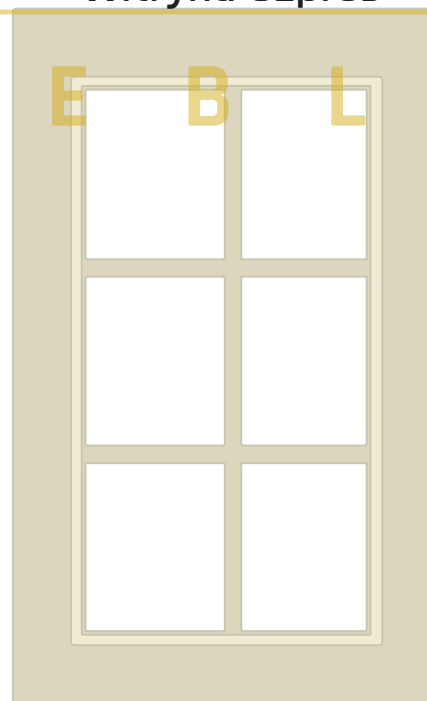

Witryna

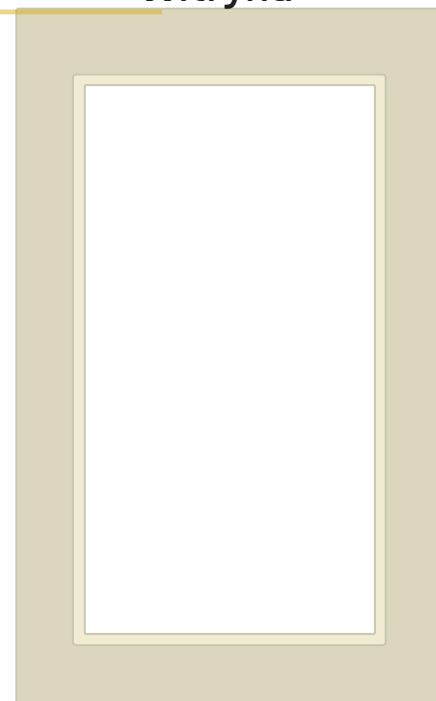

bd Bogdan Duraj

M E B L E

ER1

Ekran Ramiak 1

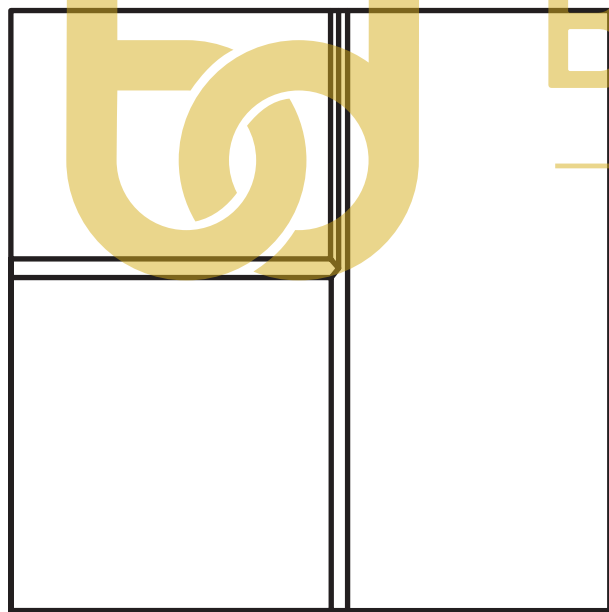
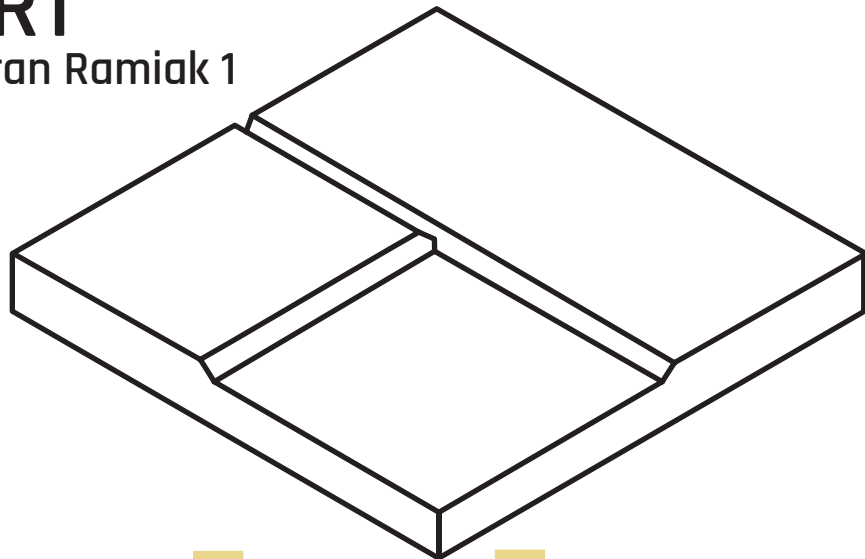

Front

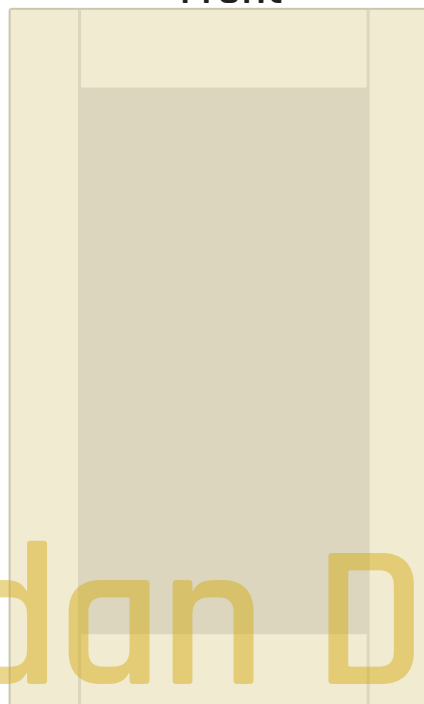

Szuflady

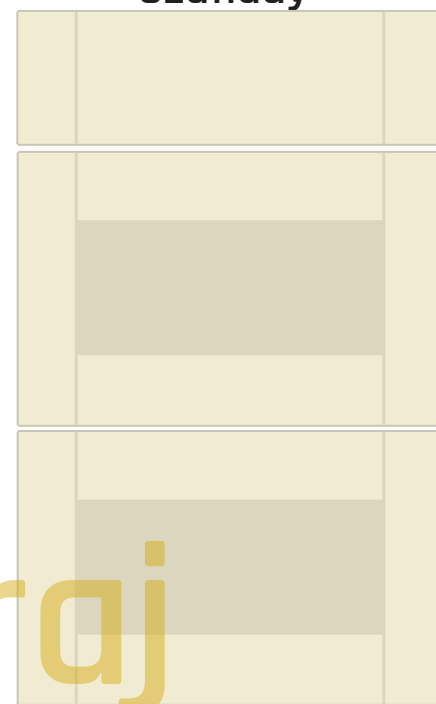

Bogdan Duraj

Witryna Szpros

Witryna

M E B L E

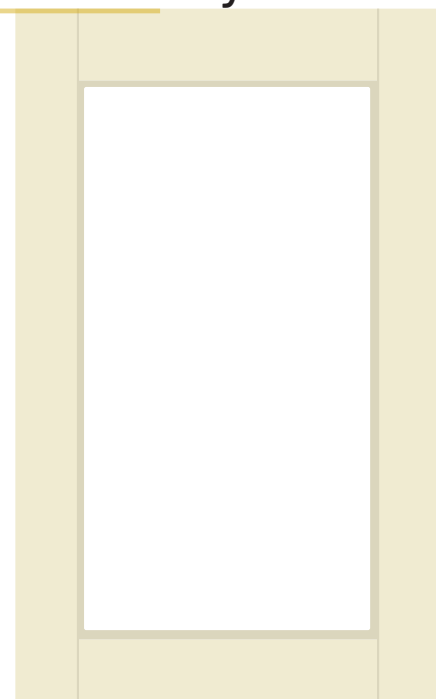
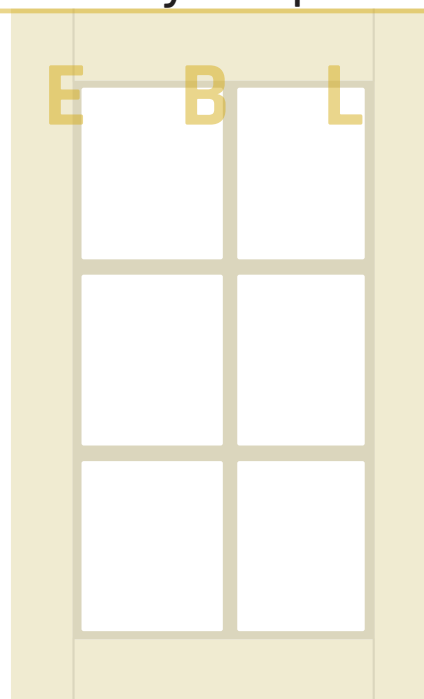

ER2

Ekran Ramiak 2

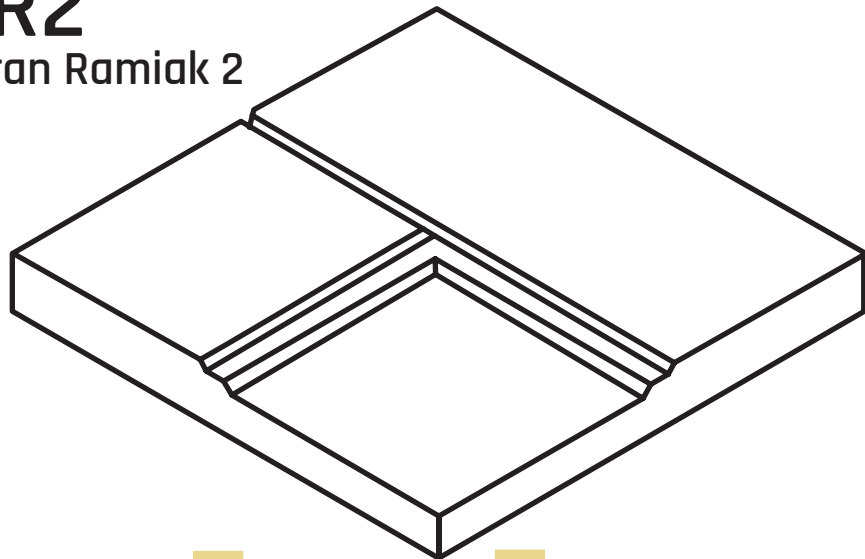

65



19

Front

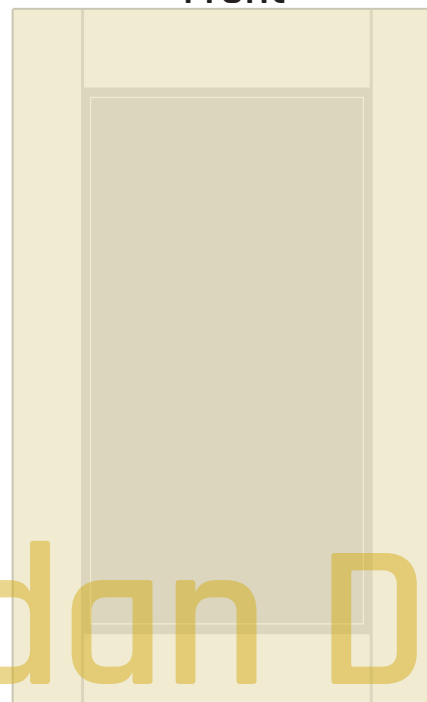

Szuflady

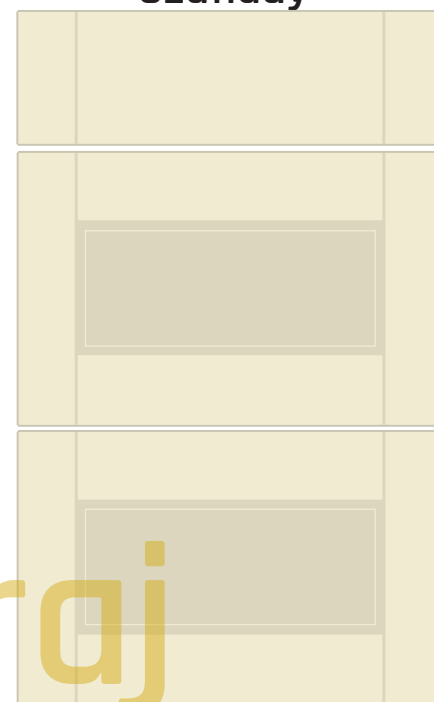

Witryna Szpros

Witryna

M E B L E

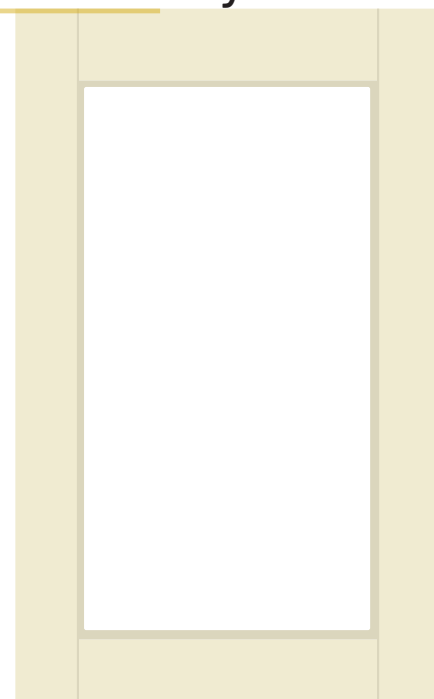
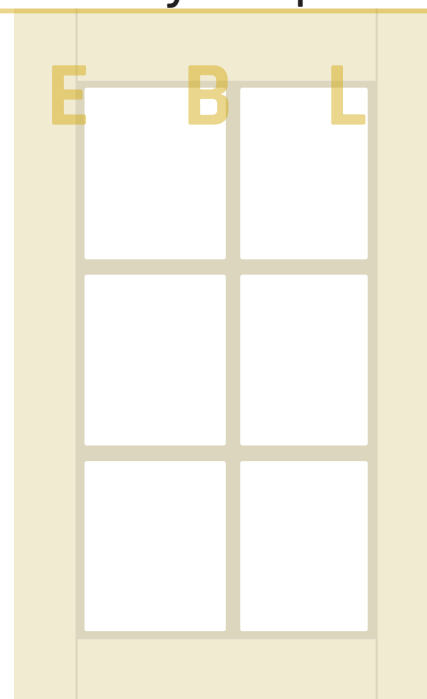

ER3

Ekran Ramiak 3

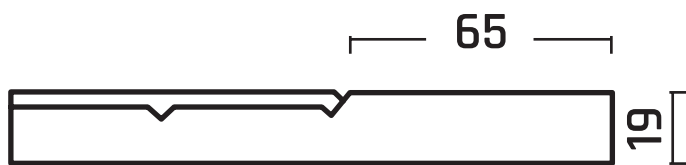
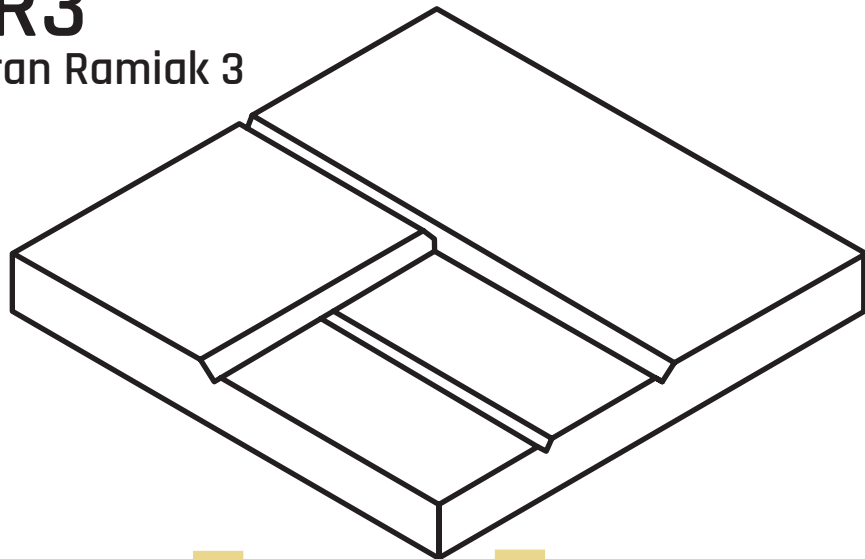

Front

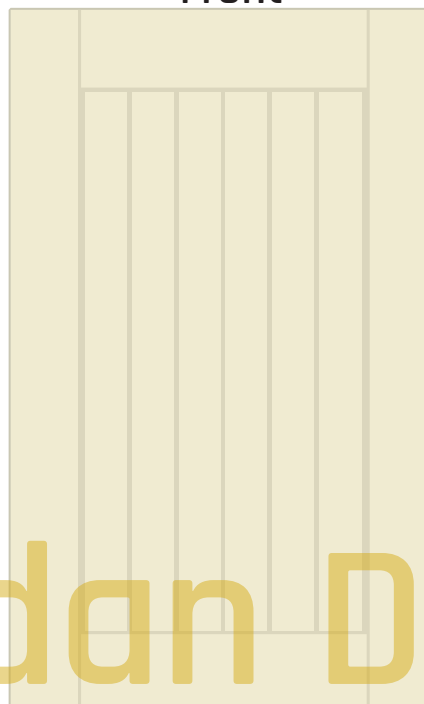

Szuflady

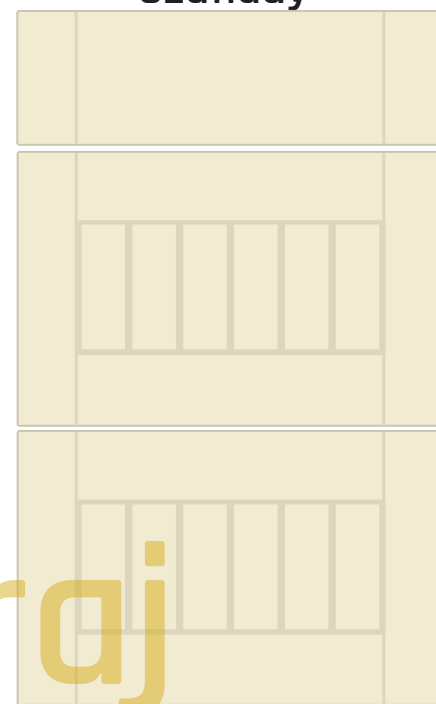

Bogdan Duraj

Witryna Szpros

Witryna

M E B L E

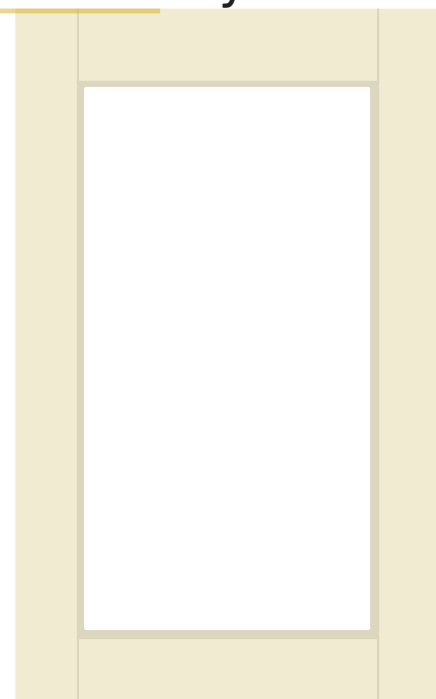
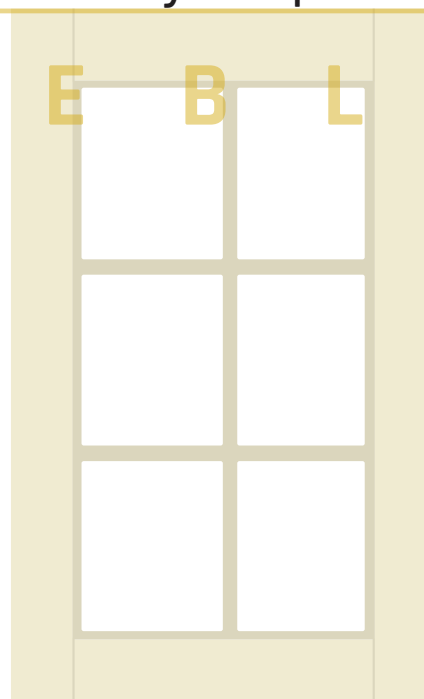

ER4

Ekran Ramiak 4

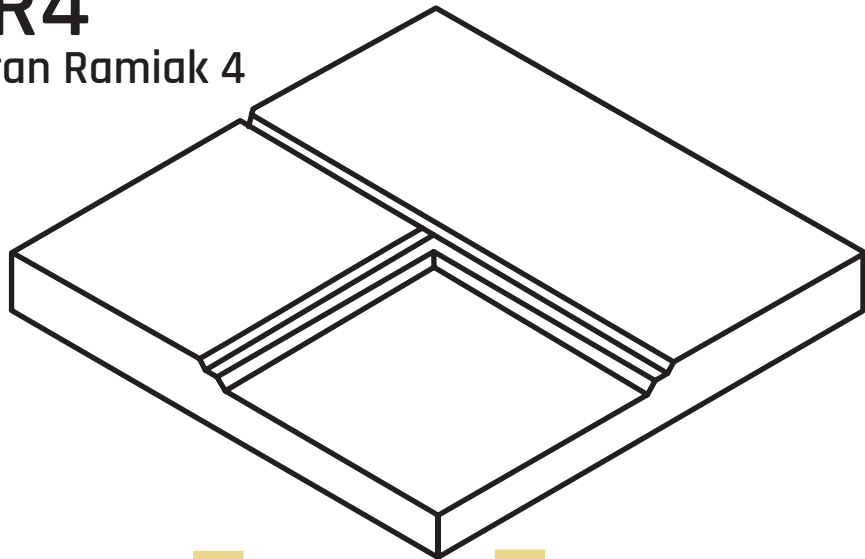

65



19

Front

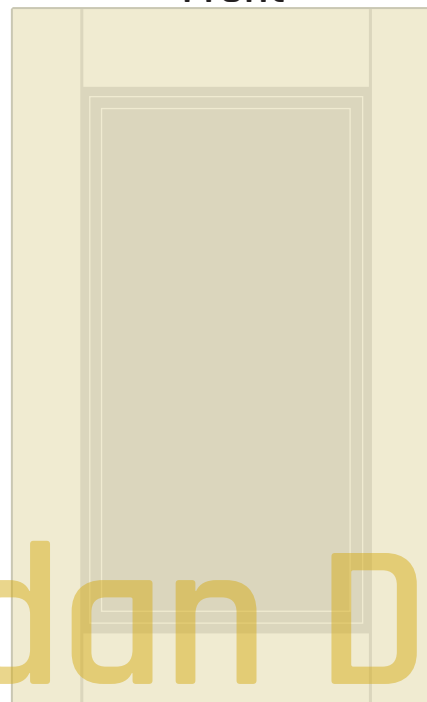

Szuflady

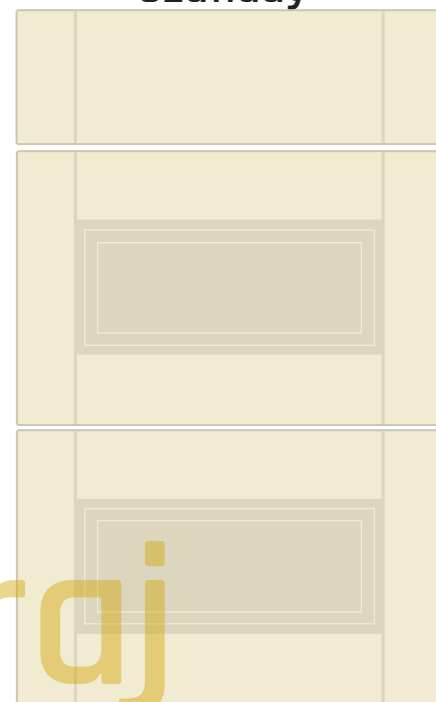

Witryna Szpros

Witryna

M E B L E

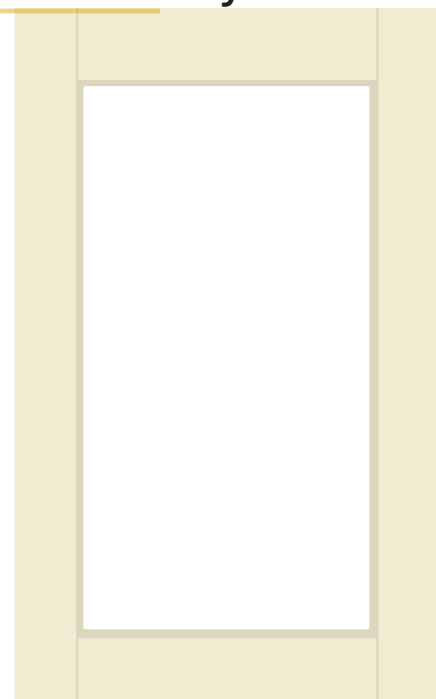
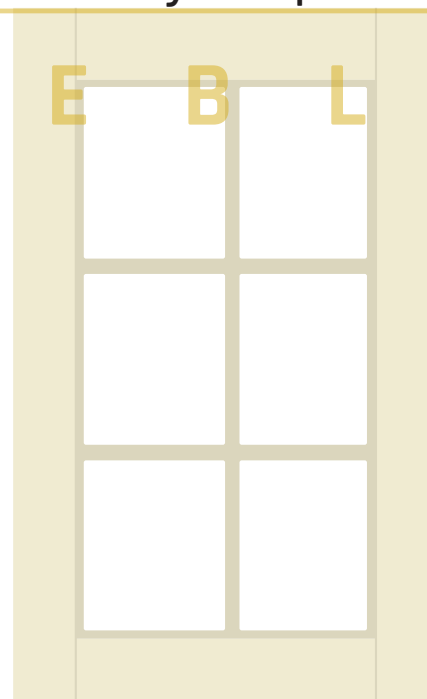

ES1

Ekran skos 1

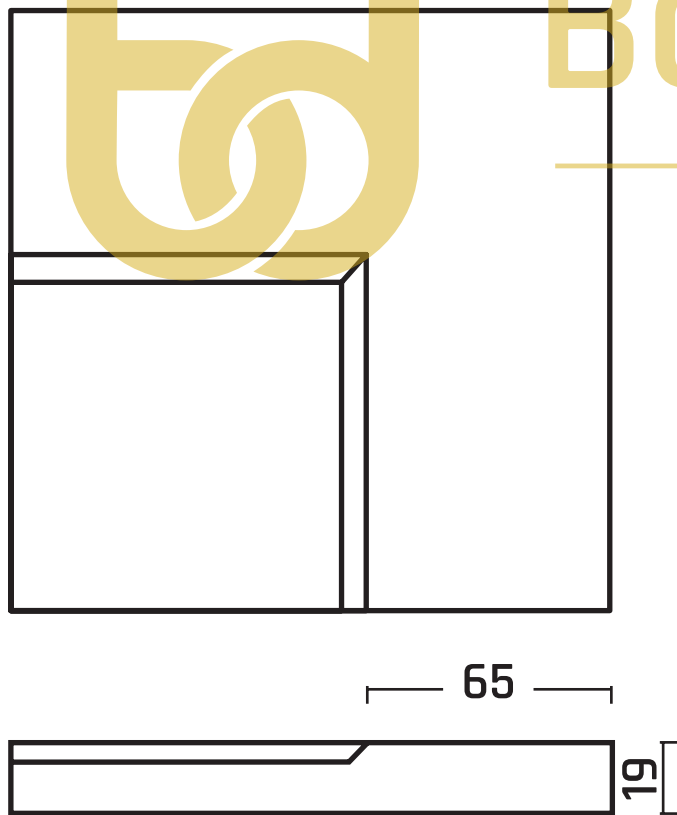
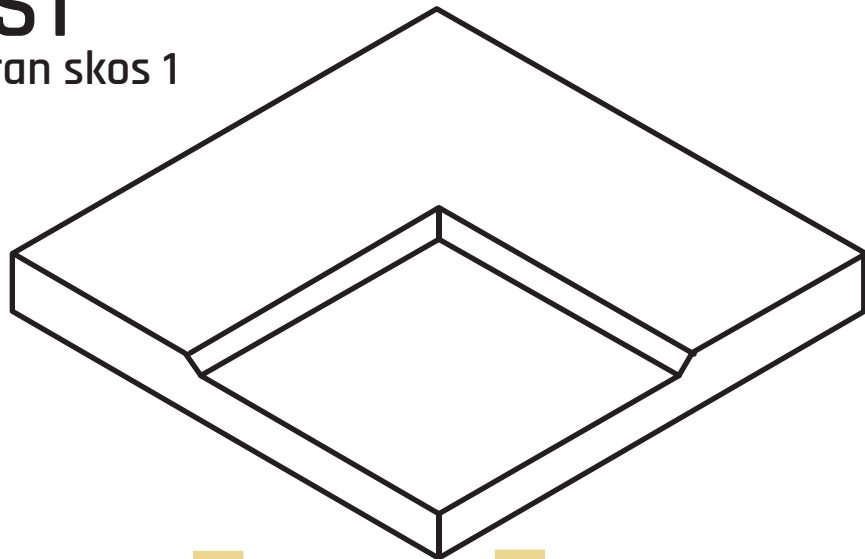

Front

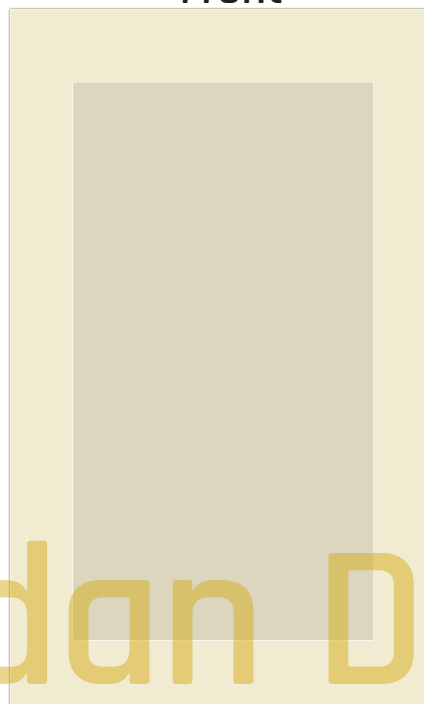

Szuflady

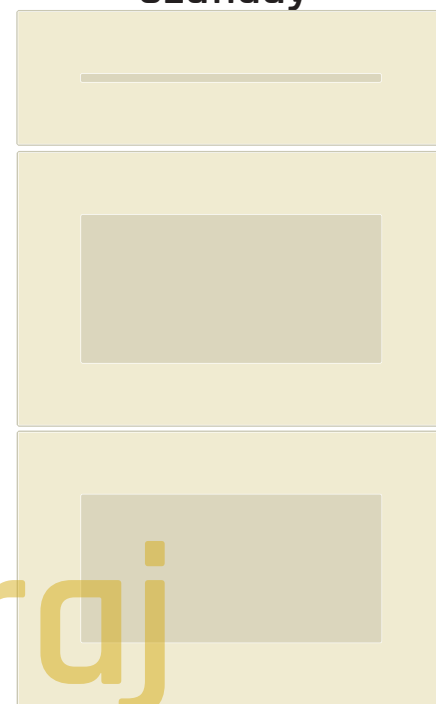

Witryna Szpros

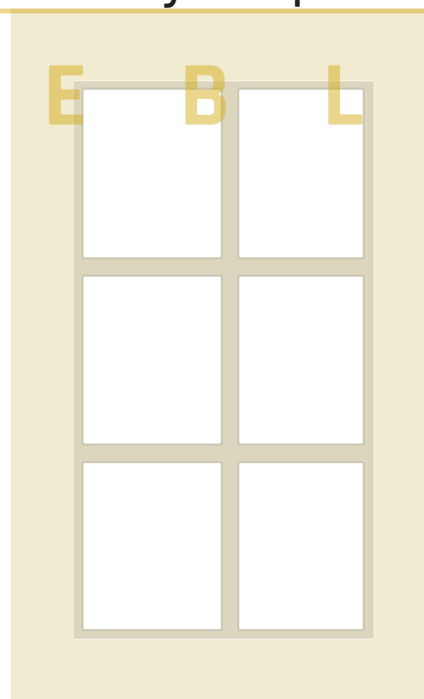

Witryna

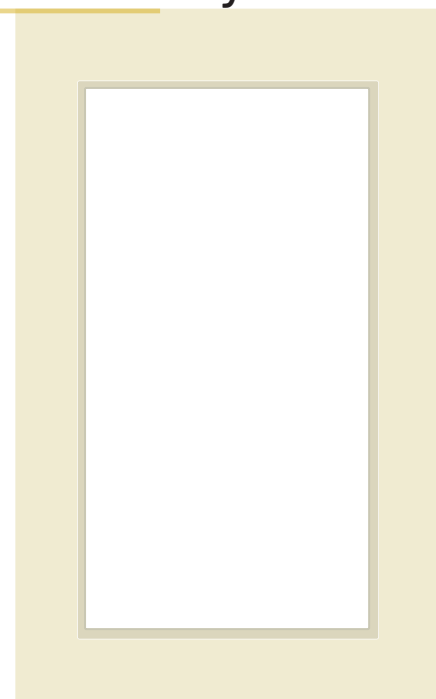

M E B L E

Bogdan Duraj

ES2

Ekran skos 2

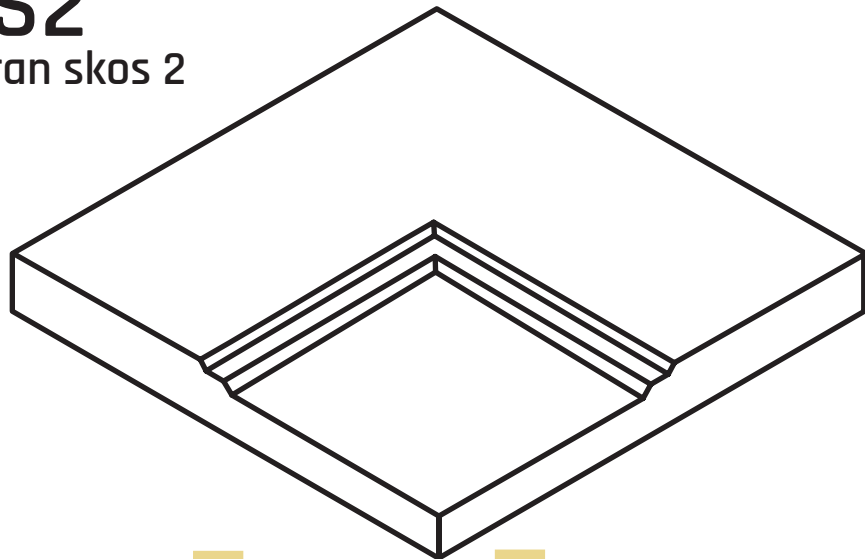

65



19

Front

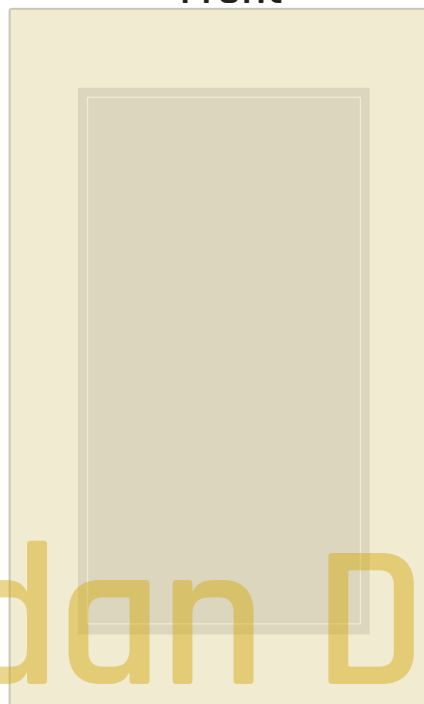

Szuflady

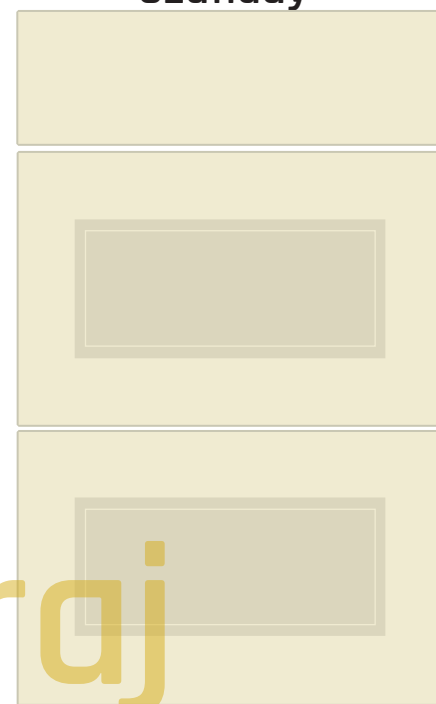

Witryna Szpros

Witryna

M E B L E

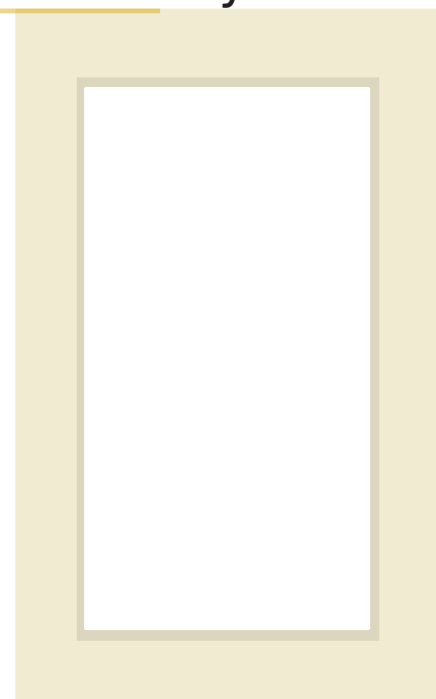
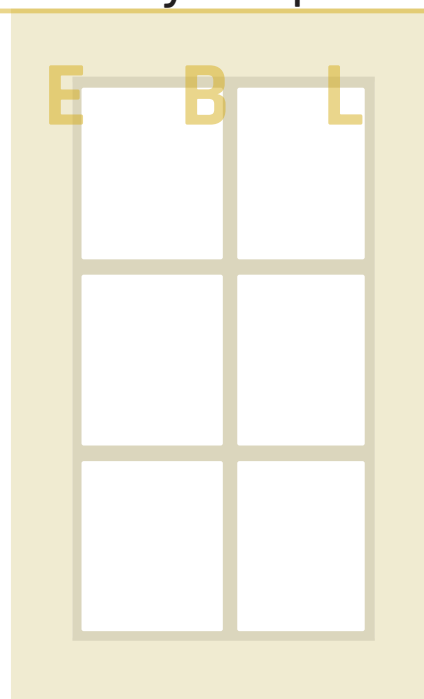

ES3

Ekran skos 3

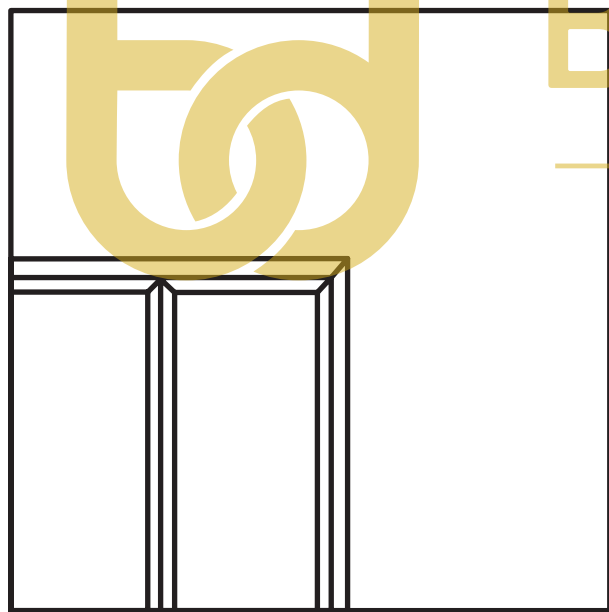
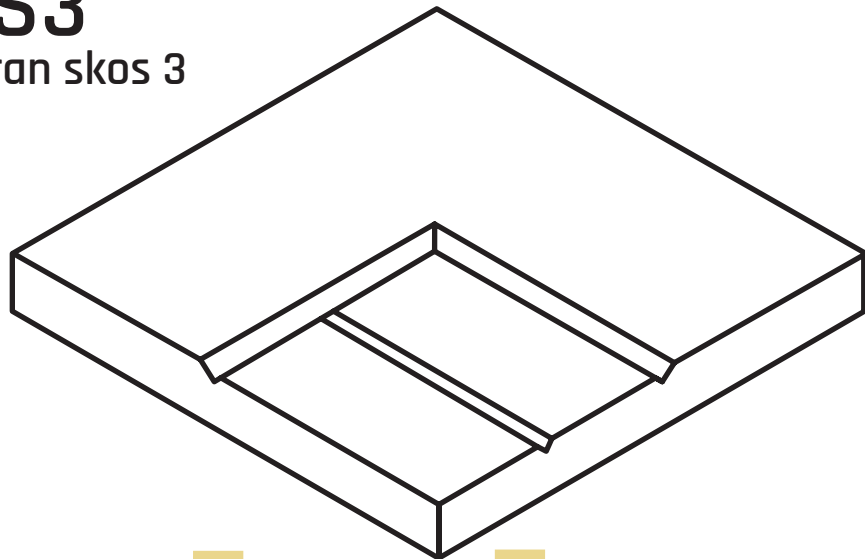

65



19

Front

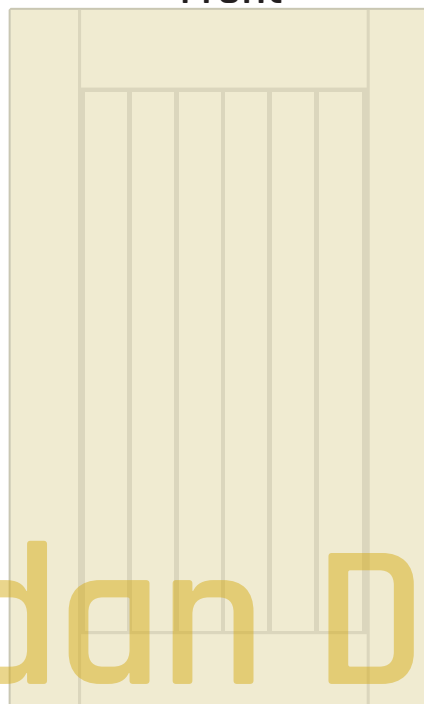

Szuflady

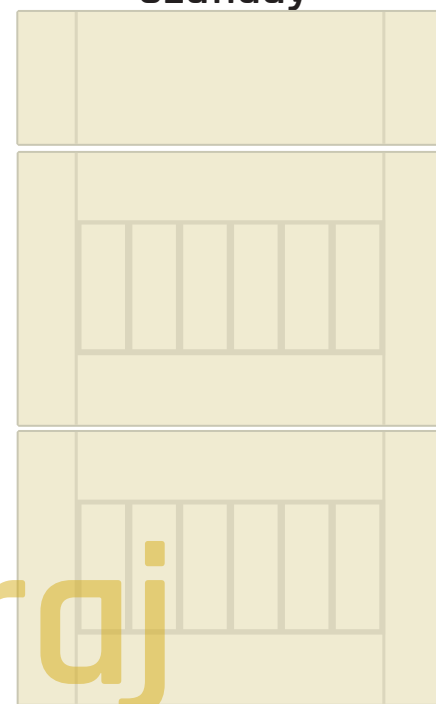

Witryna Szpros

Witryna

M E B L E

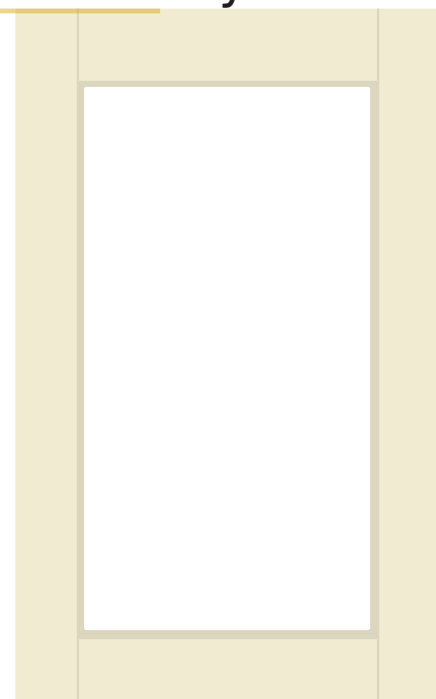
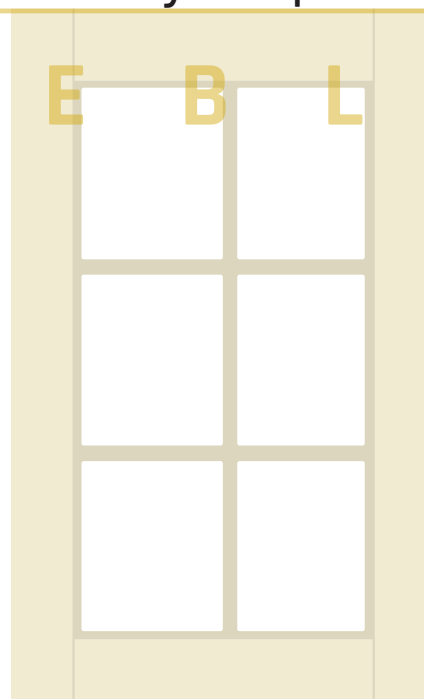

ES4

Ekran skos 4

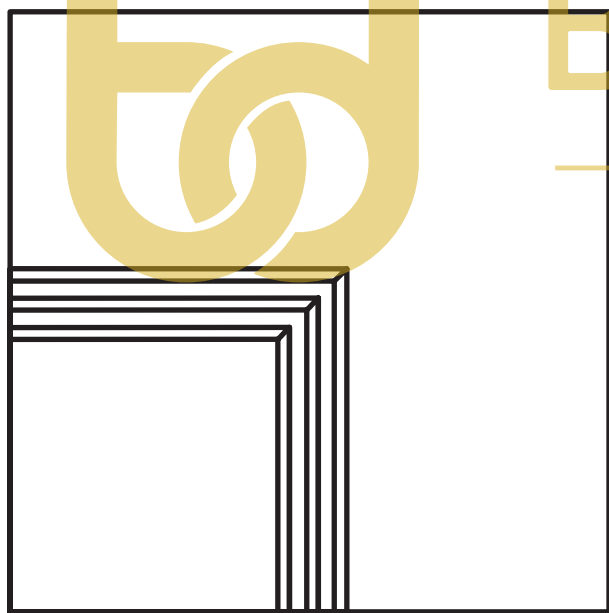
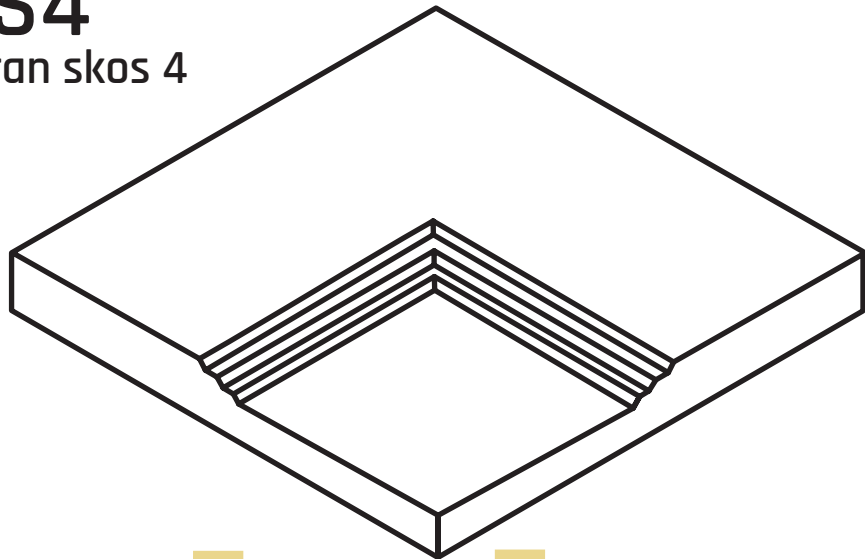

65



19

Front

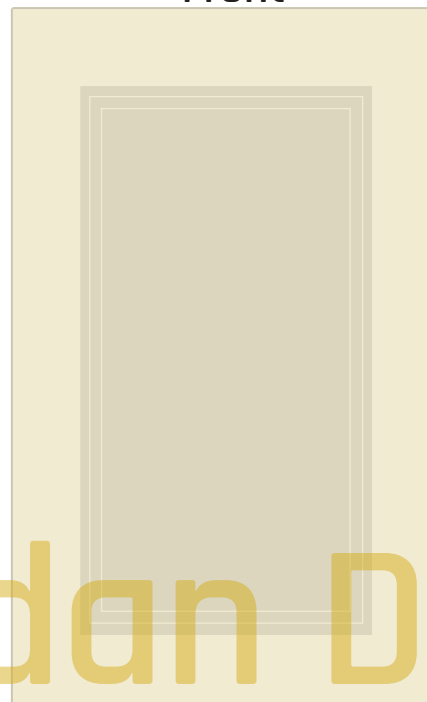

Witryna Szpros

Szuflady

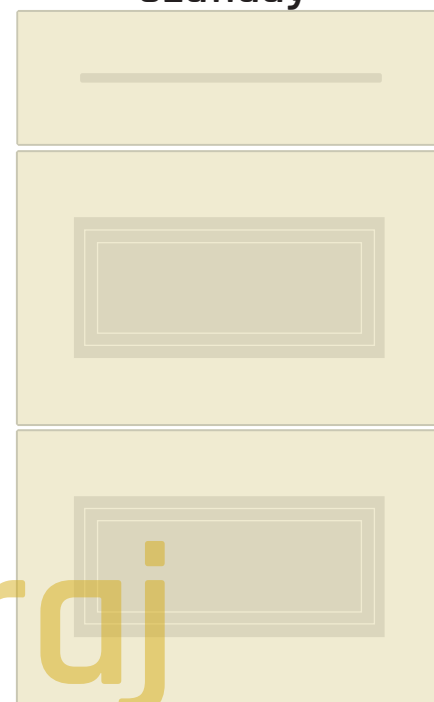

Witryna

M E B L E

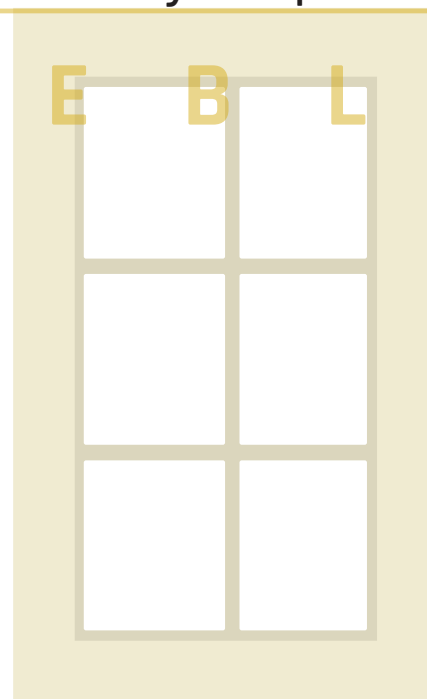

EP1

Ekran Prosty 1

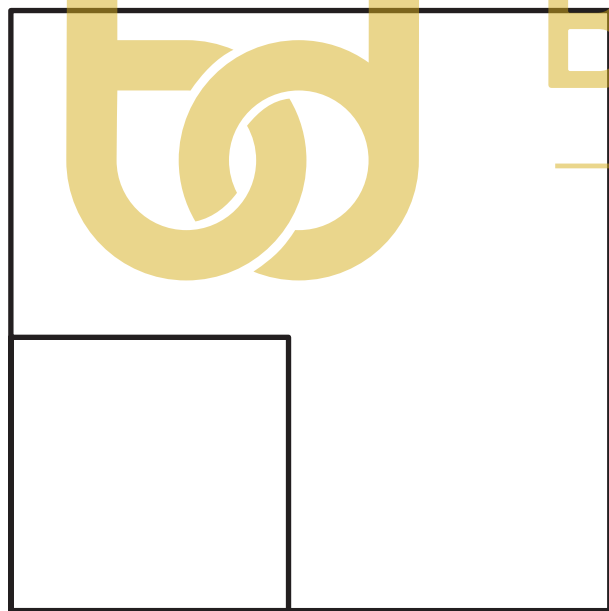
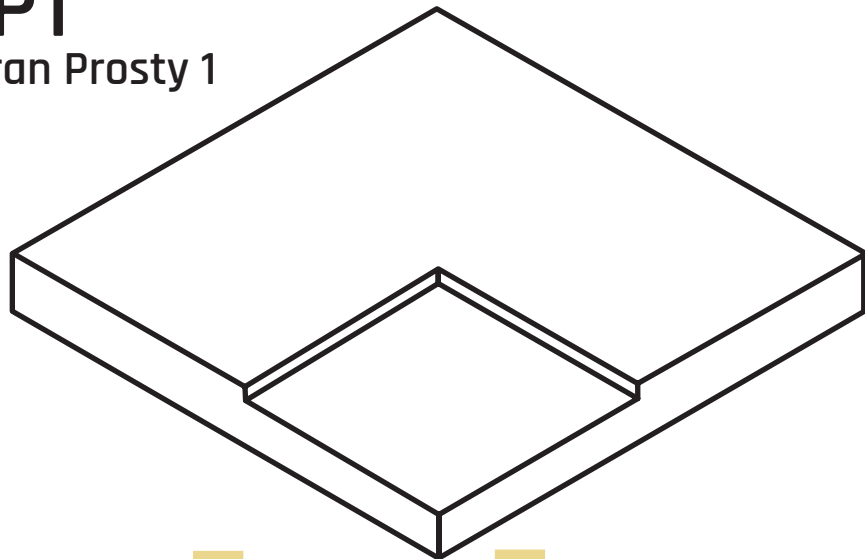

95



Front

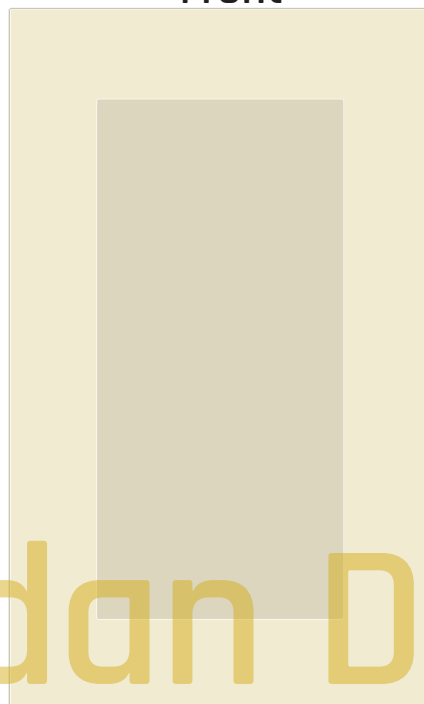

Szuflady

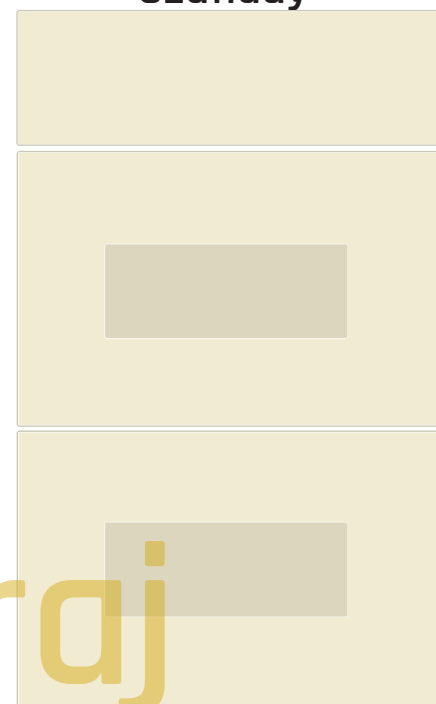

Witryna Szpros

Witryna

M E B L E

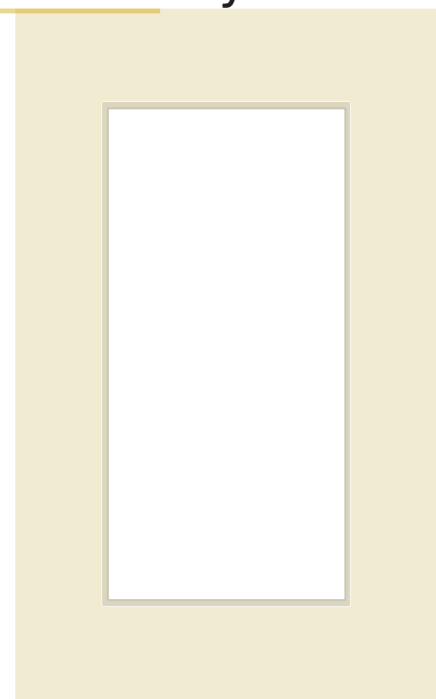
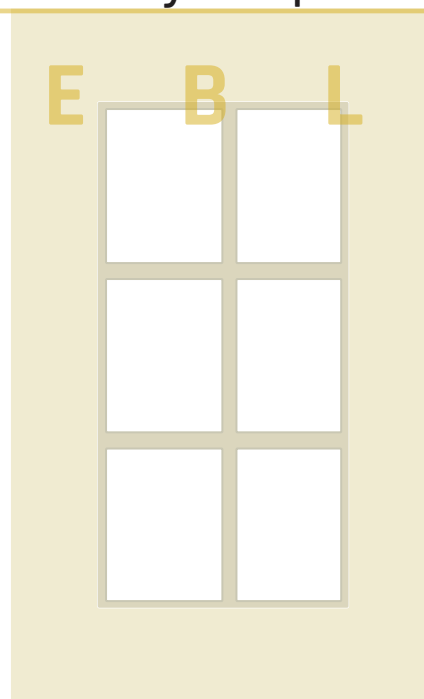

EP2

Ekran Prosty 2

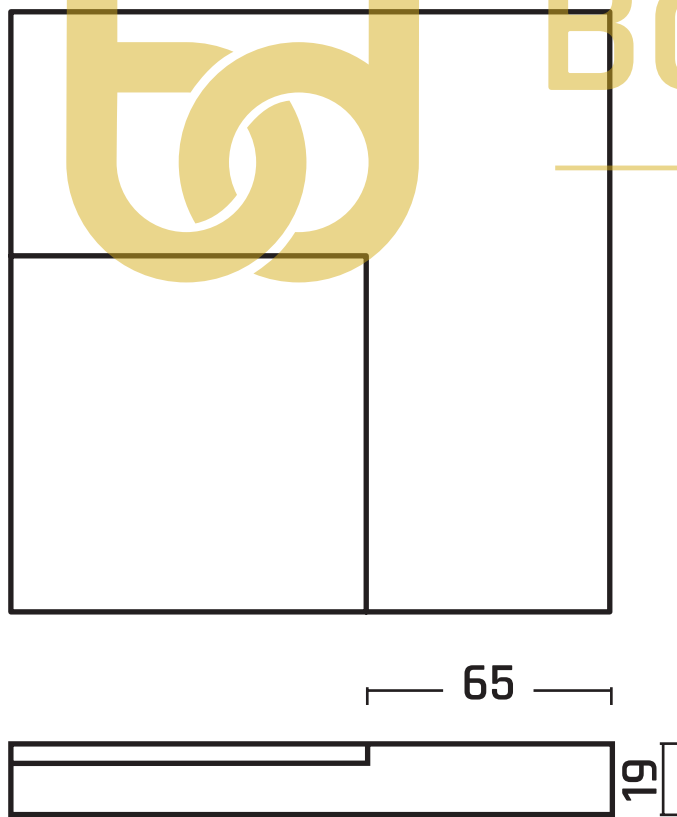
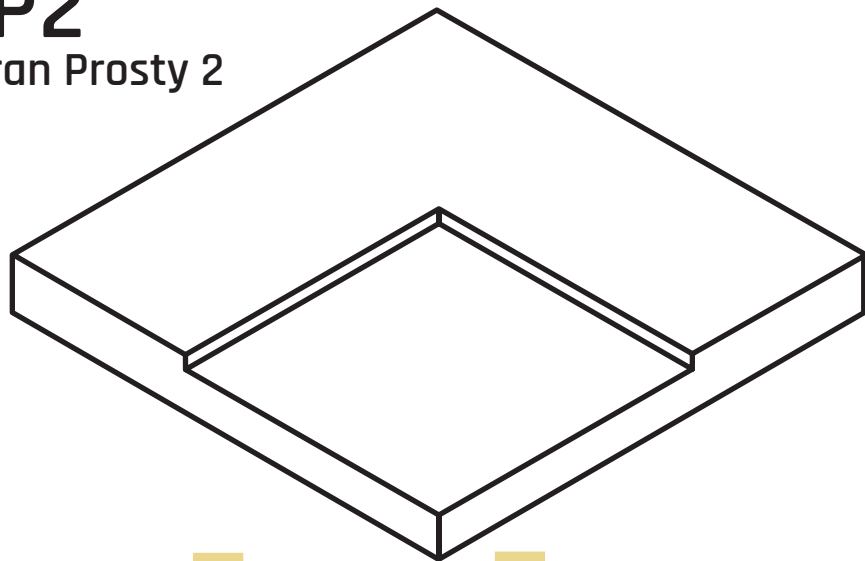

Front

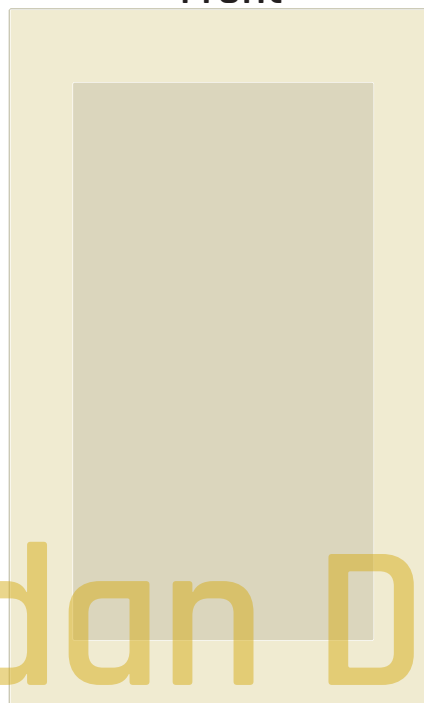

Szuflady

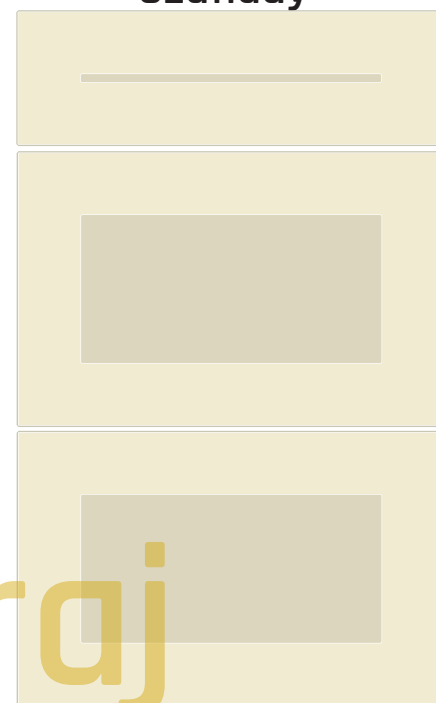

Witryna Szpros

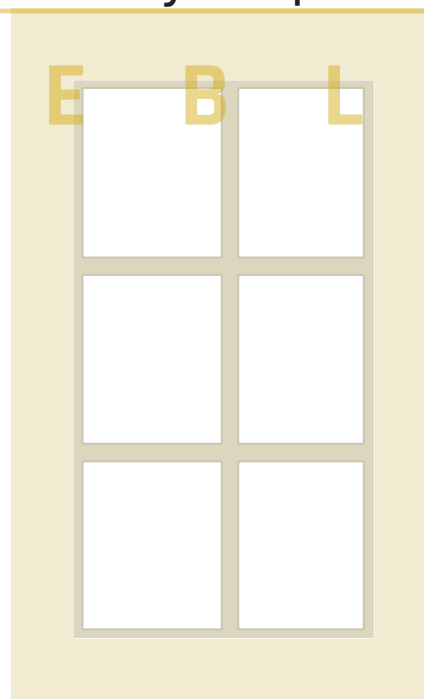

Witryna

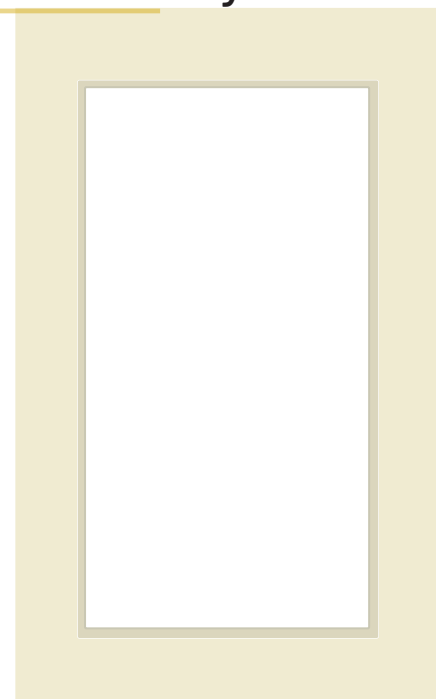

bd Bogdan Duraj

M E B L E

EP3

Ekran Prosty 3

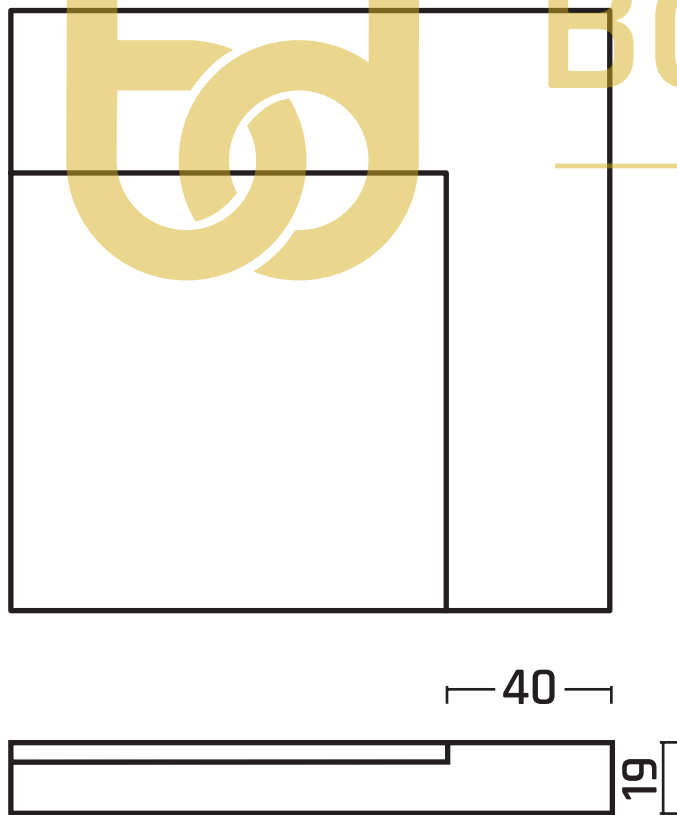
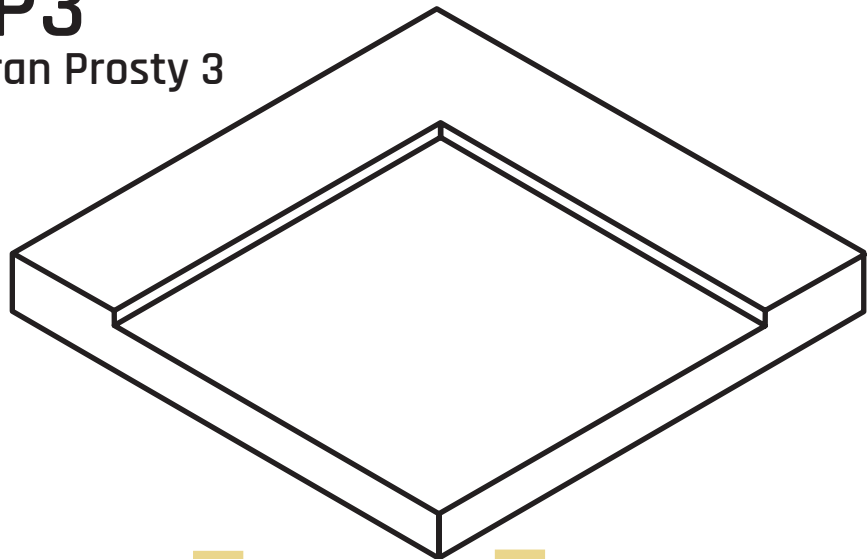

Front

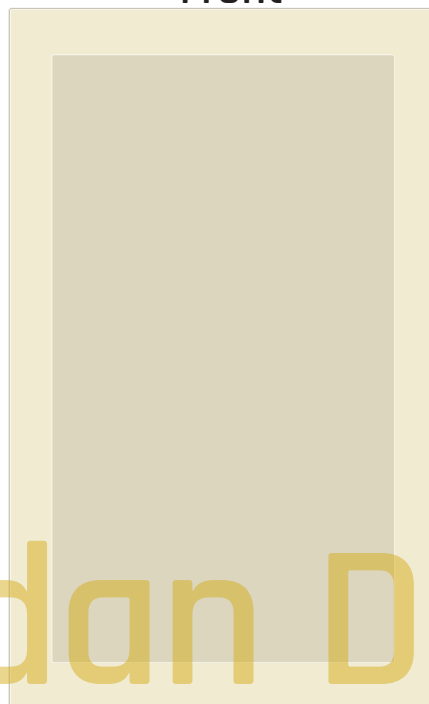

Szuflady

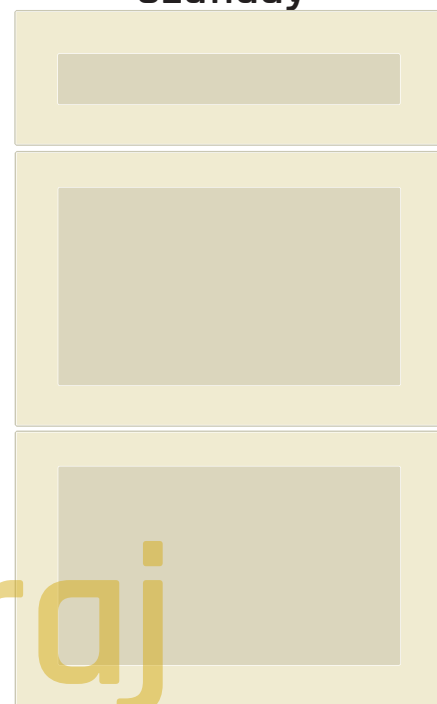

Witryna Szpros

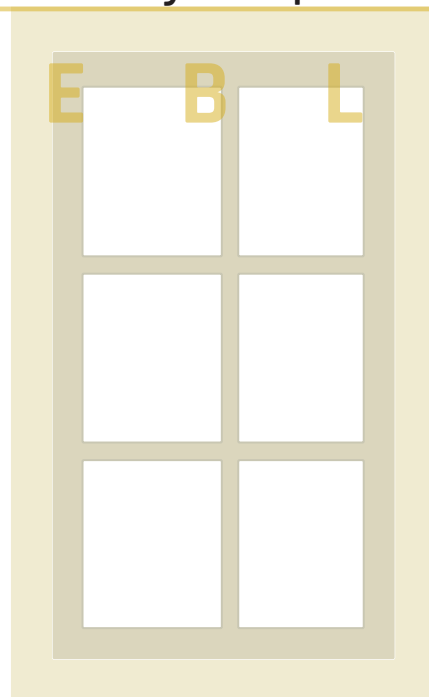

Witryna

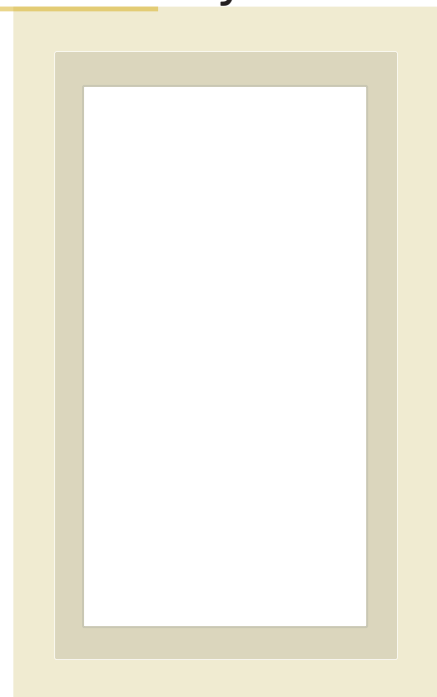

MEBLE Bogdan Duraj

EP4

Ekran Prosty 4

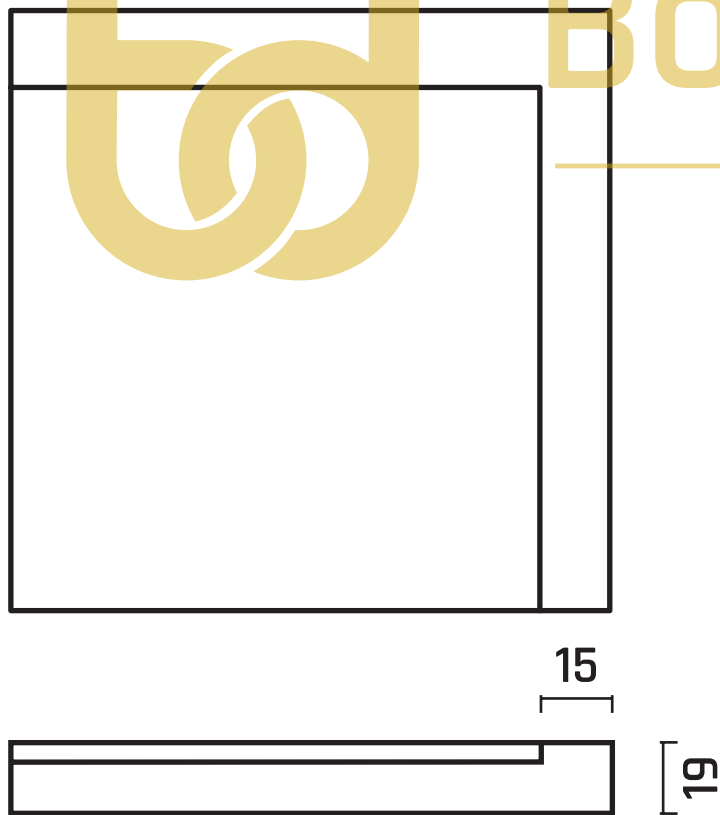
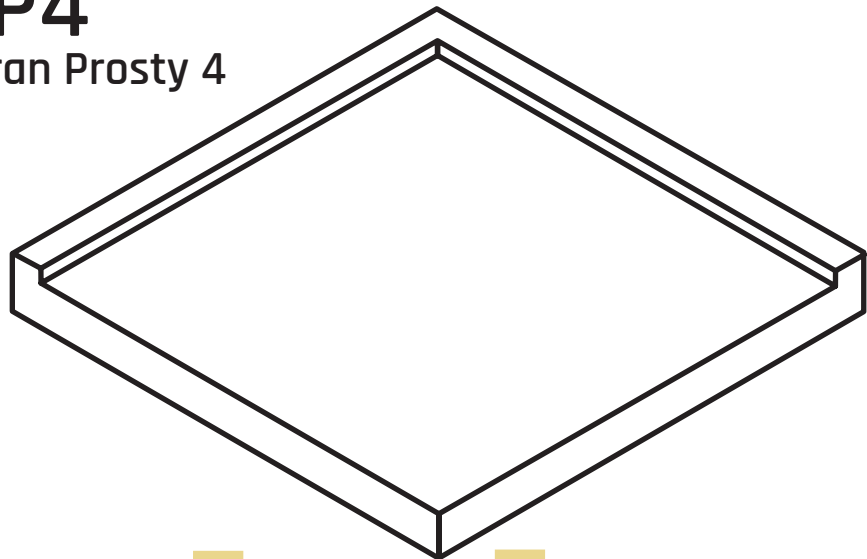

Front

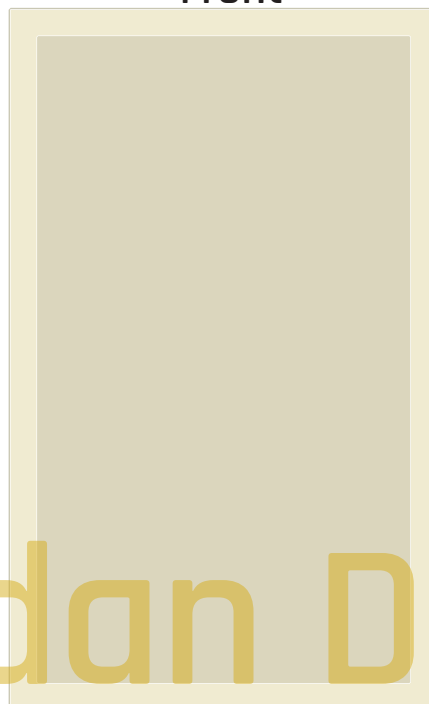

Szuflady

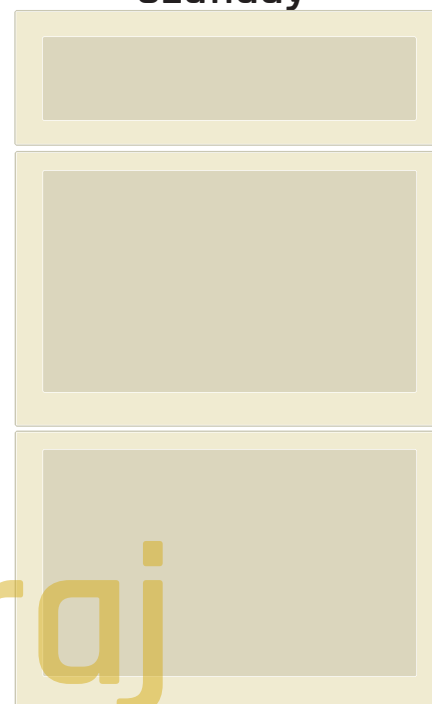

Bogdan Duraj

Witryna Szpros

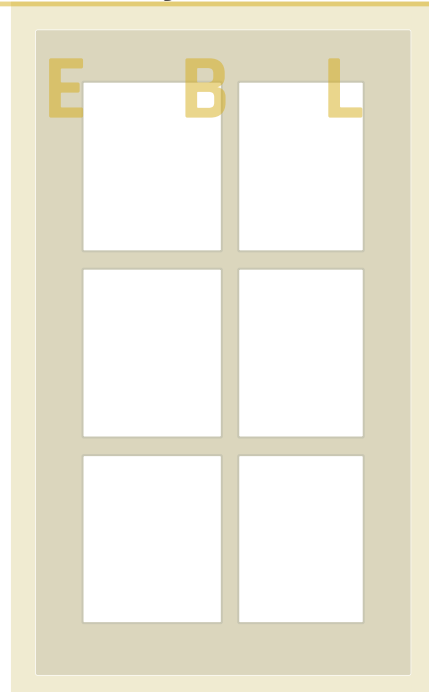

Witryna

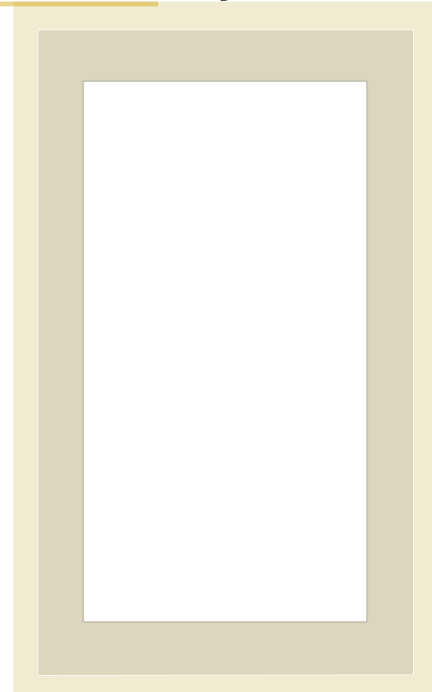

M E B L E

KR1
Kaseton
Ramiak 1

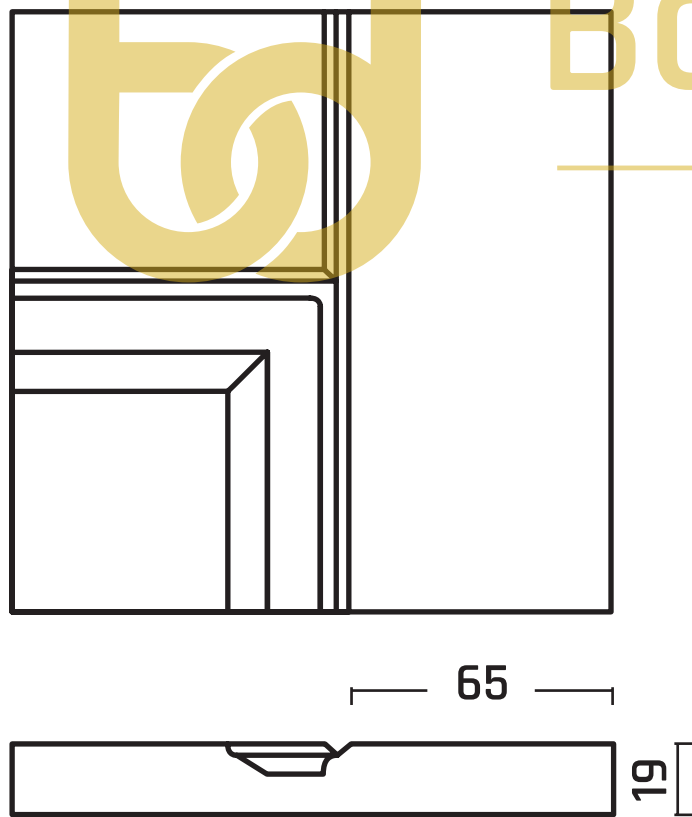
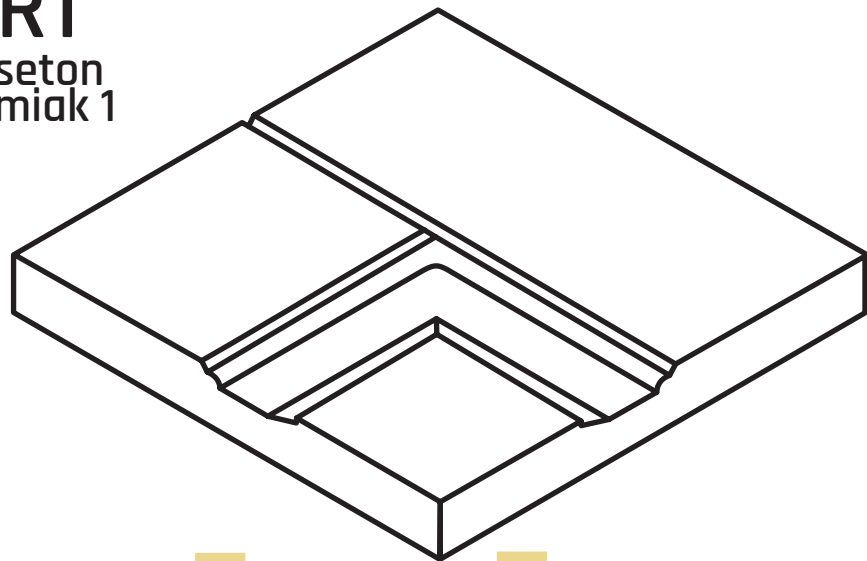

Front

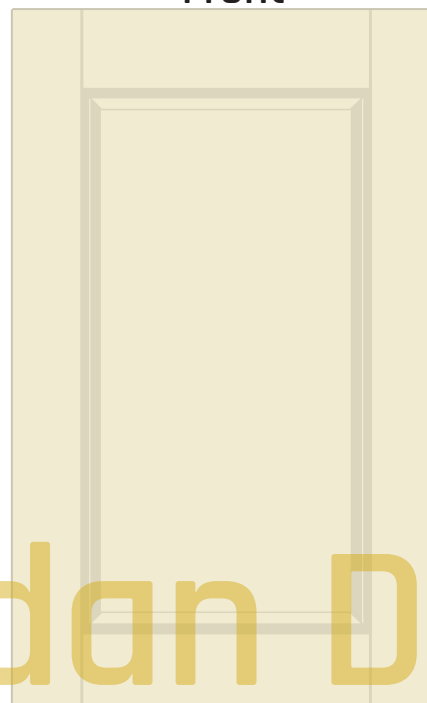

Szuflady

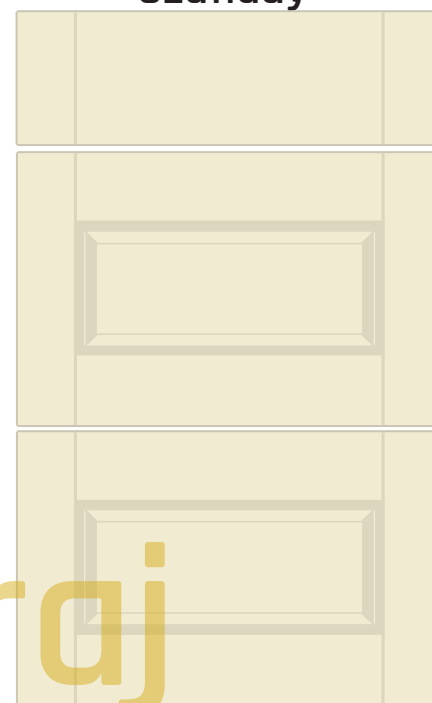

Witryna Szpros

Witryna

M E B L E

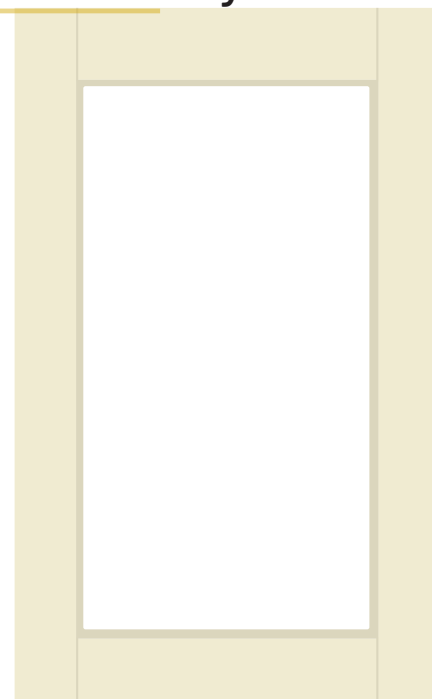
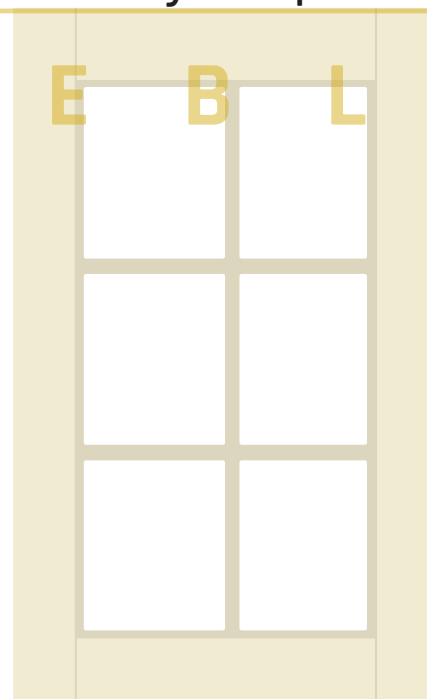

KR2
Kaseton
Ramiak 2

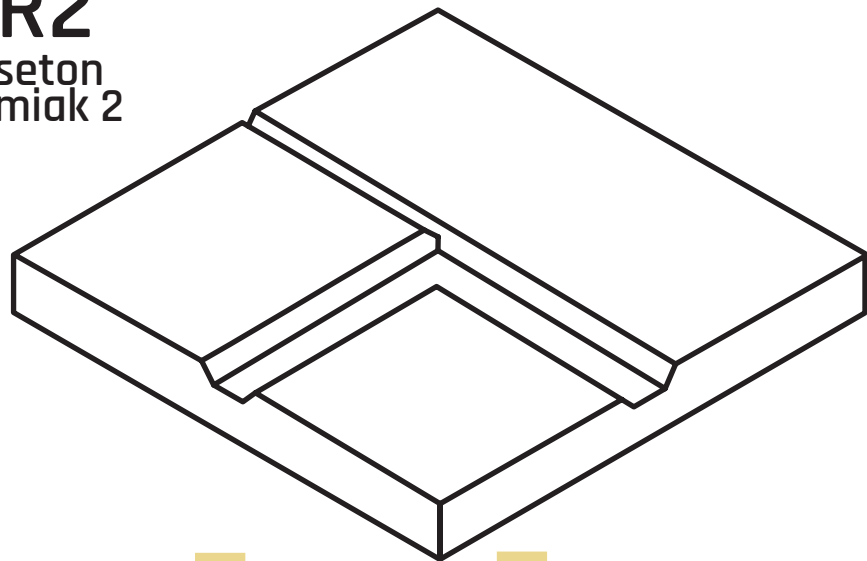

Front

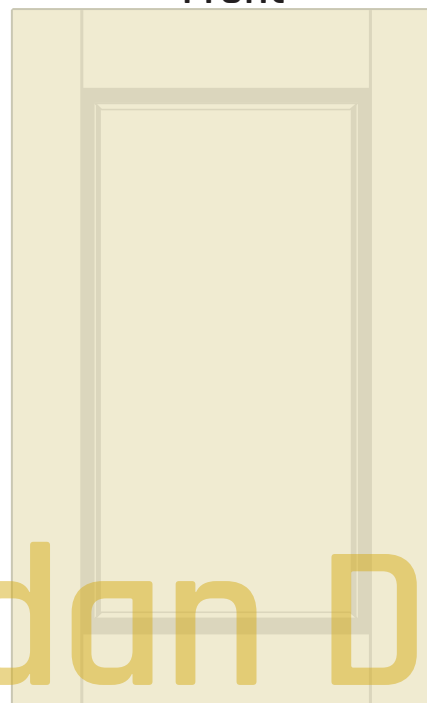

Szuflady

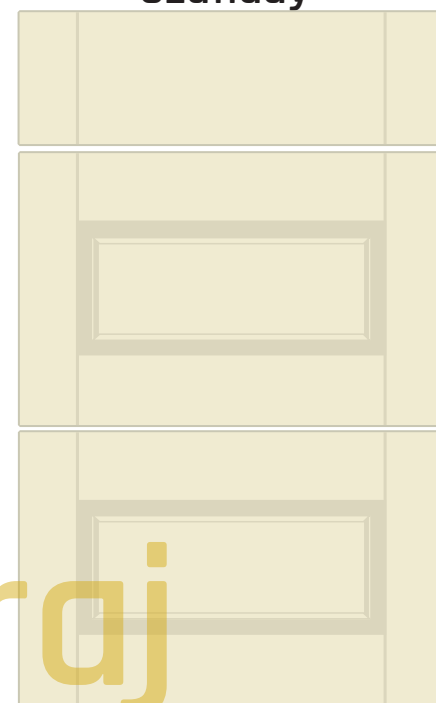

Witryna Szpros

Witryna

M E B L E

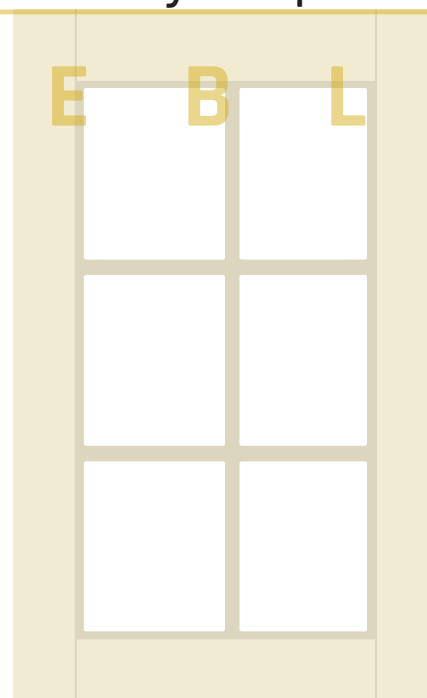

KR3
Kaseton
Ramiak 3

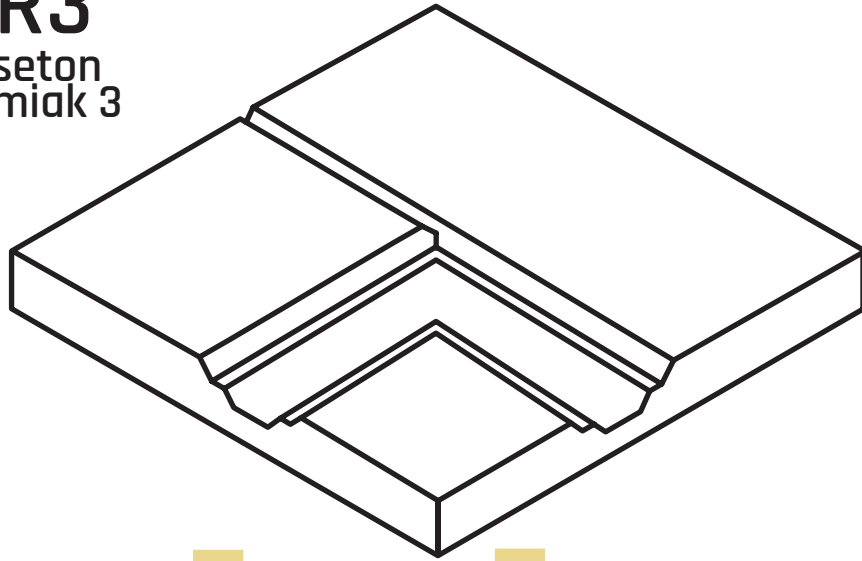

Front

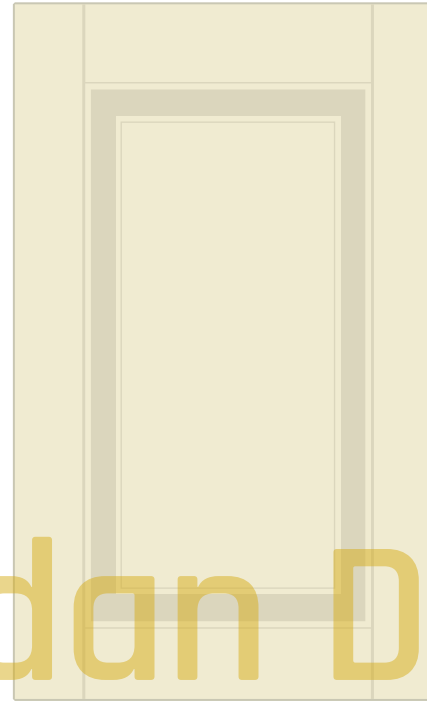

Witryna Szpros

Szuflady

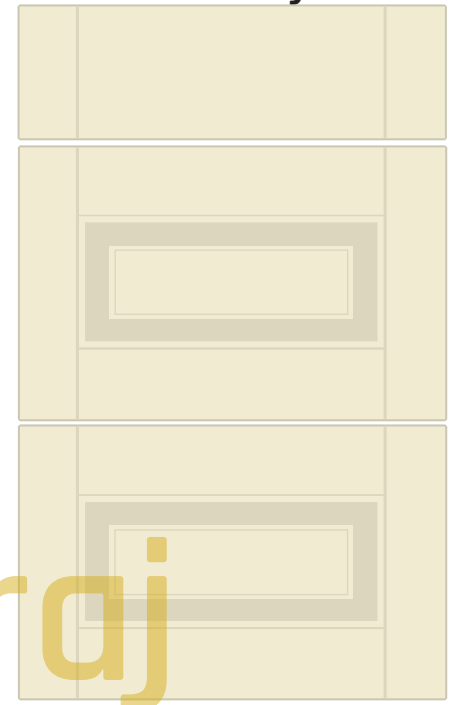

Witryna

M E B L E

Bogdan Duraj

KR4
Kaseton
Ramiak 4

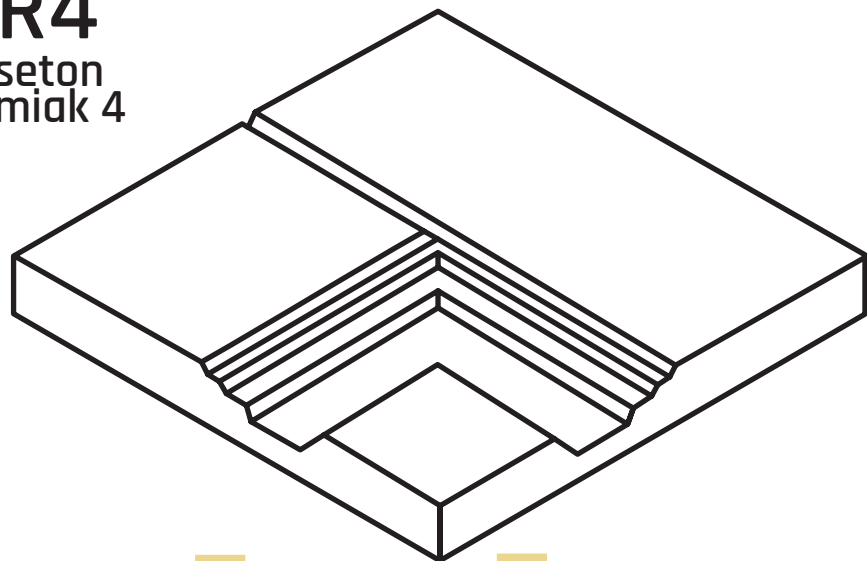

Front

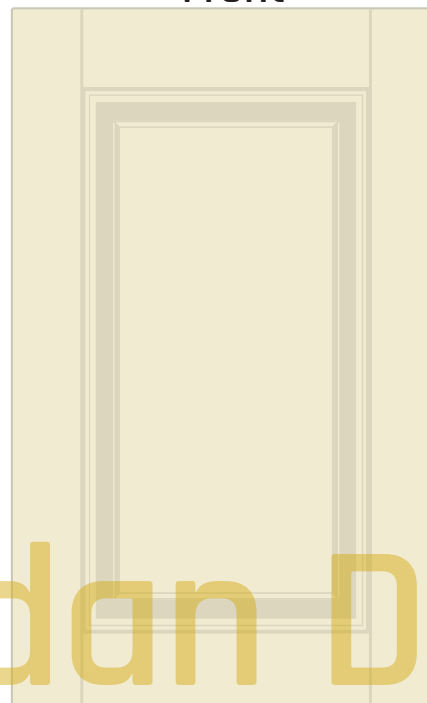

Szuflady

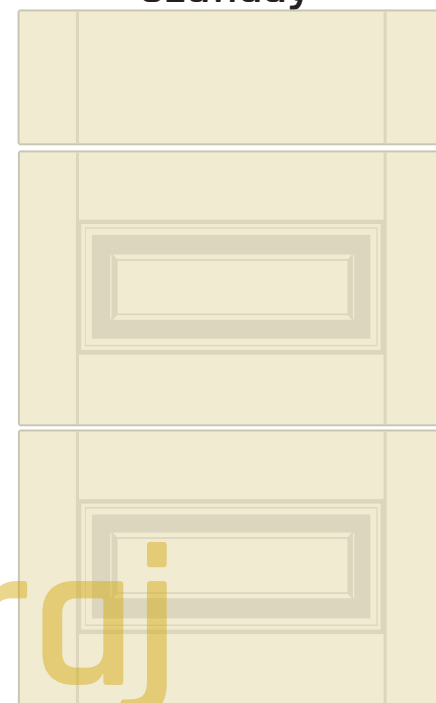

Witryna Szpros

Witryna

M E B L E

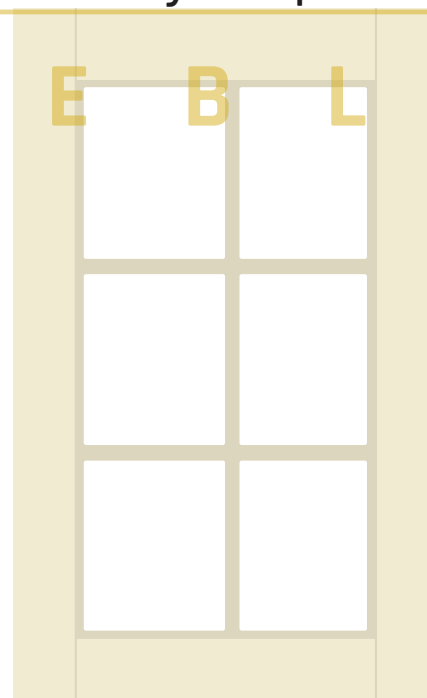

K1
Kaseton 1

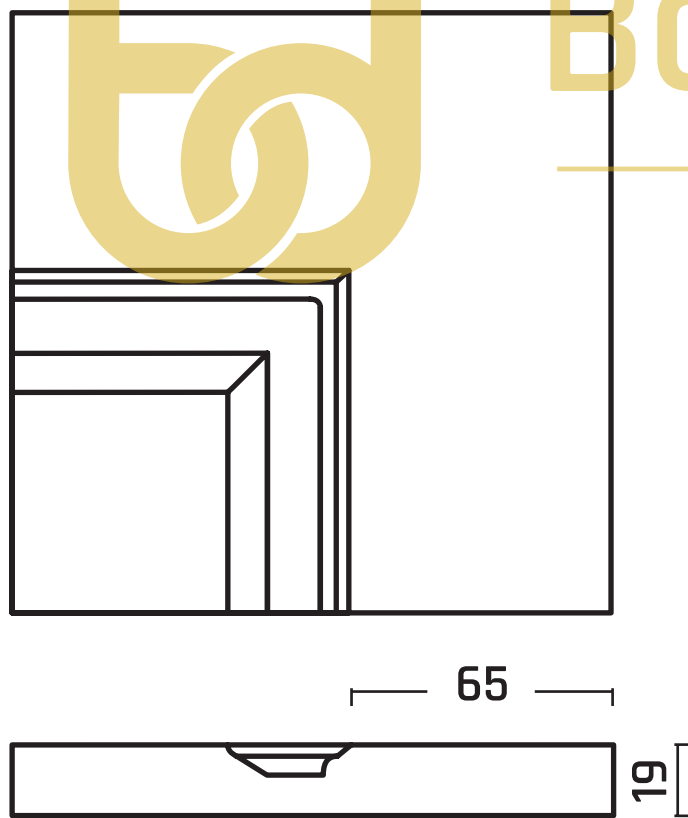
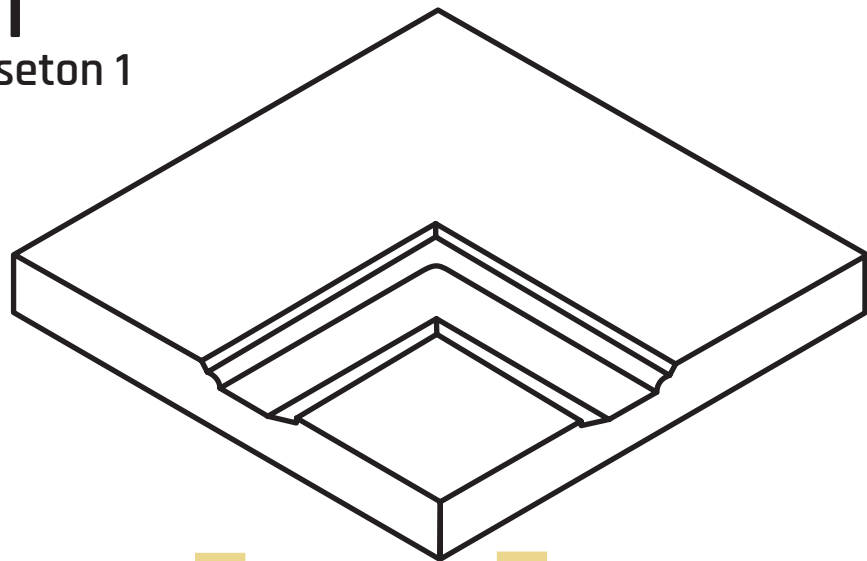

Front

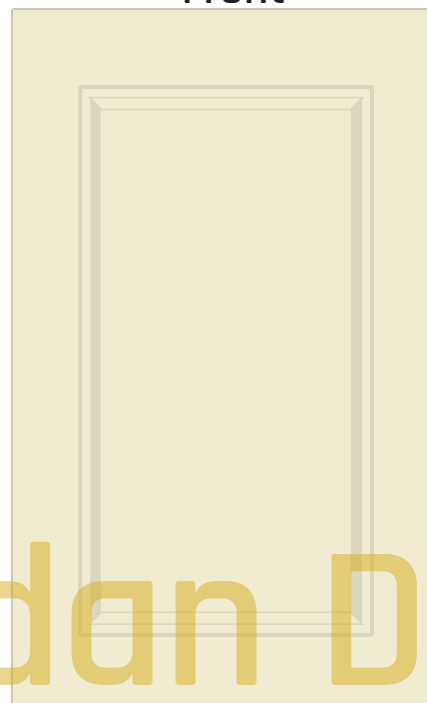

Szuflady

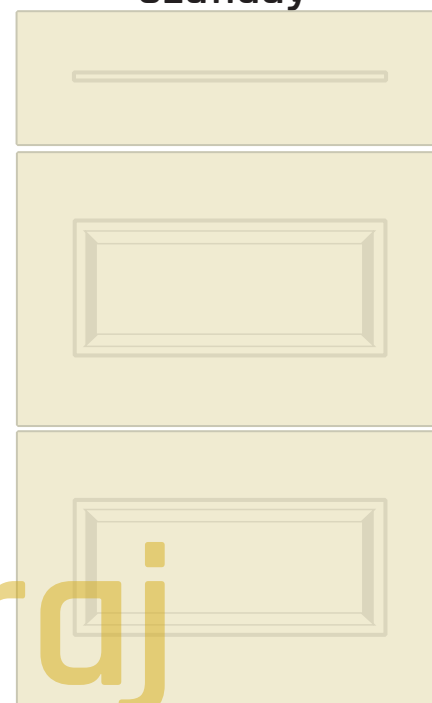

Witryna Szpros

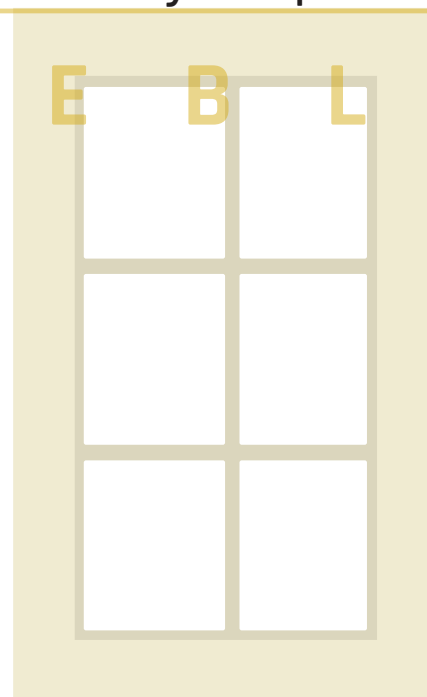

Witryna

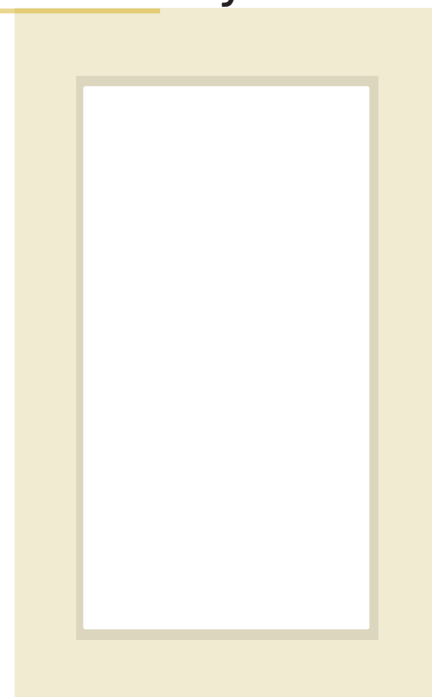

M E B L E

K2
Kaseton 2

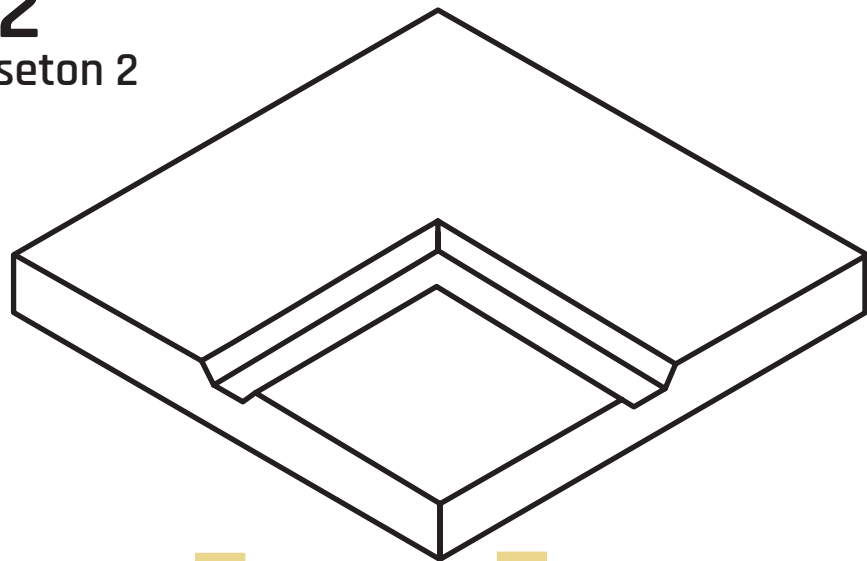

Front

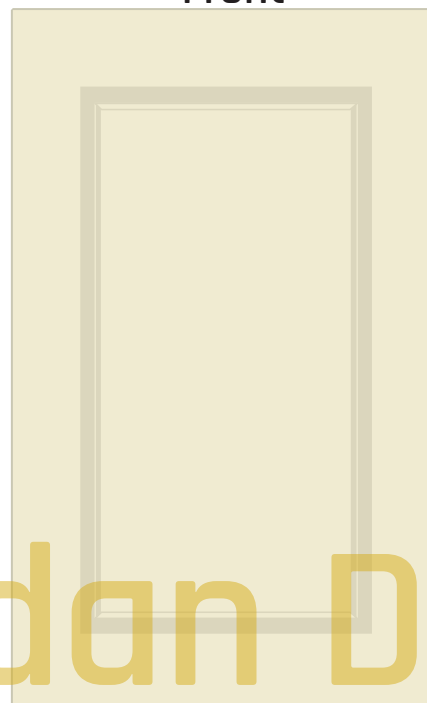

Szuflady

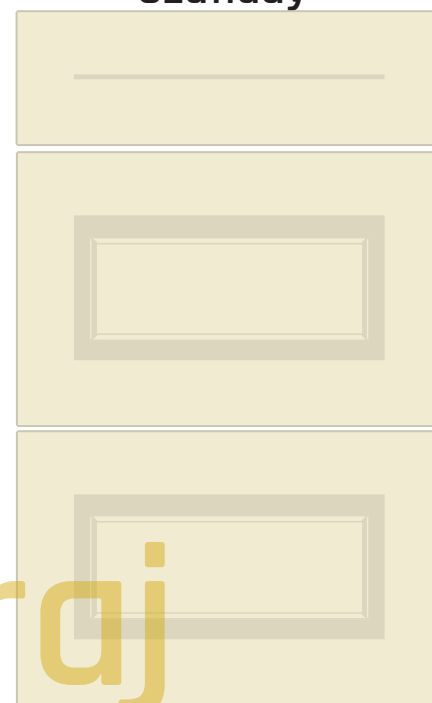

Witryna Szpros

Witryna

M E B L E

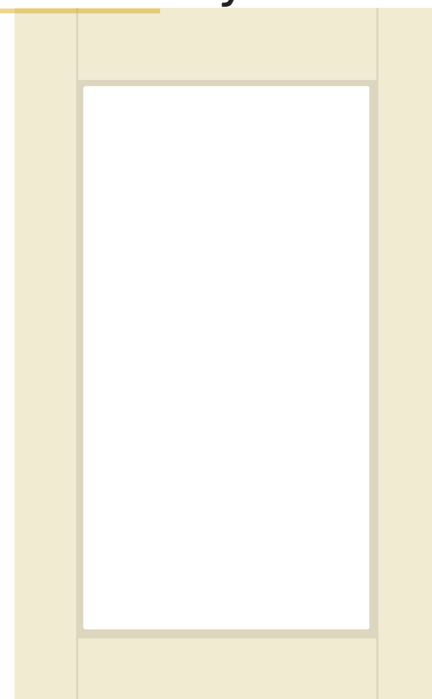
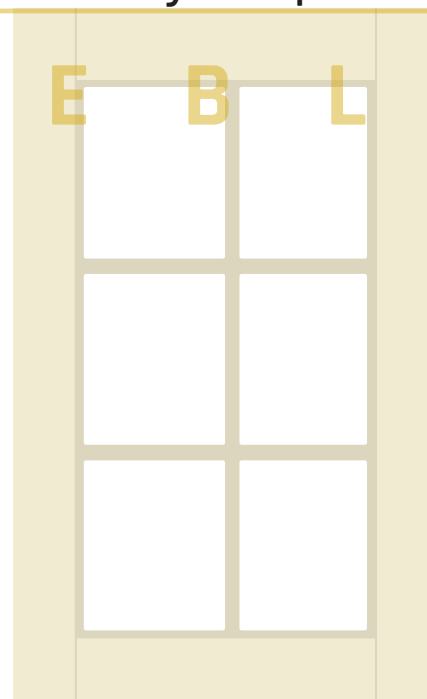

K3

Kaseton 3

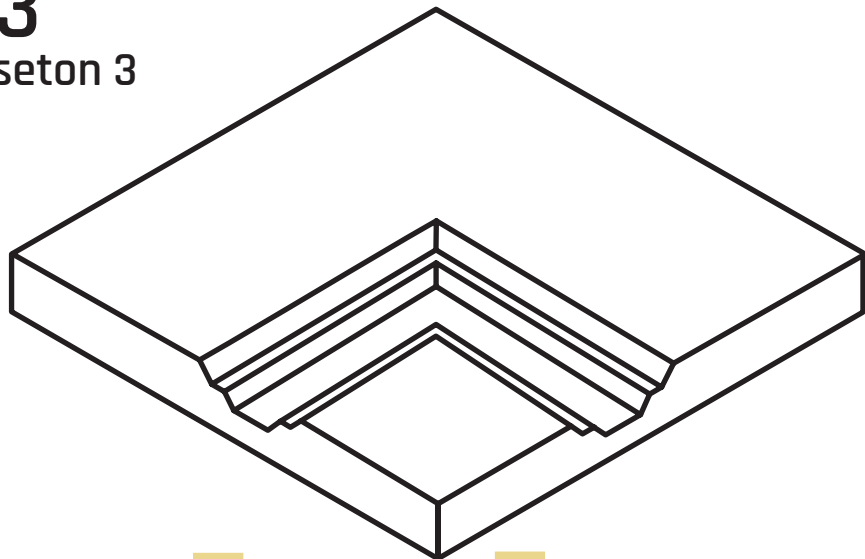

65



19

Front

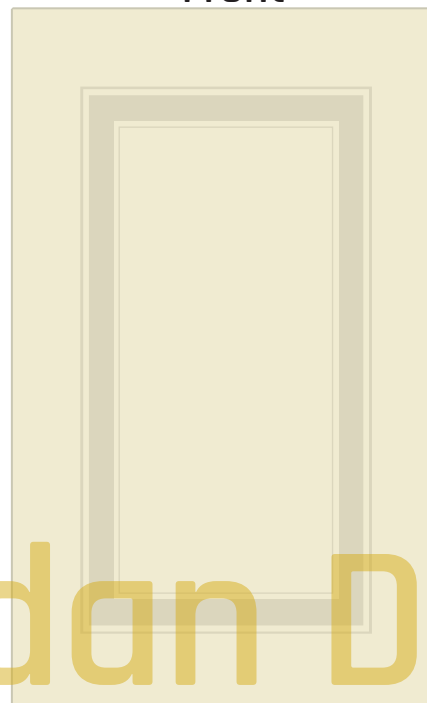

Szuflady

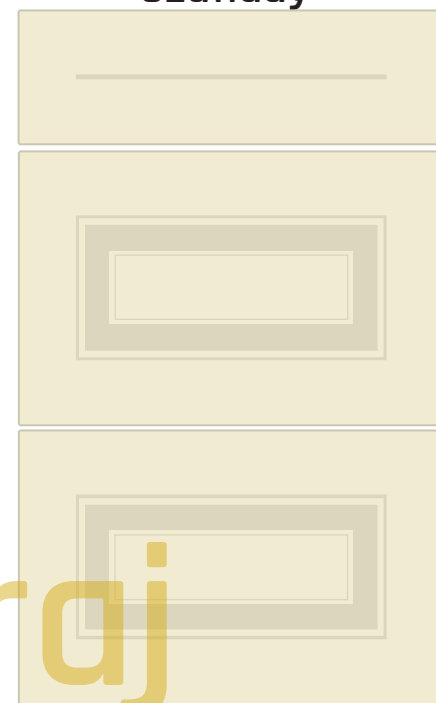

Witryna Szpros

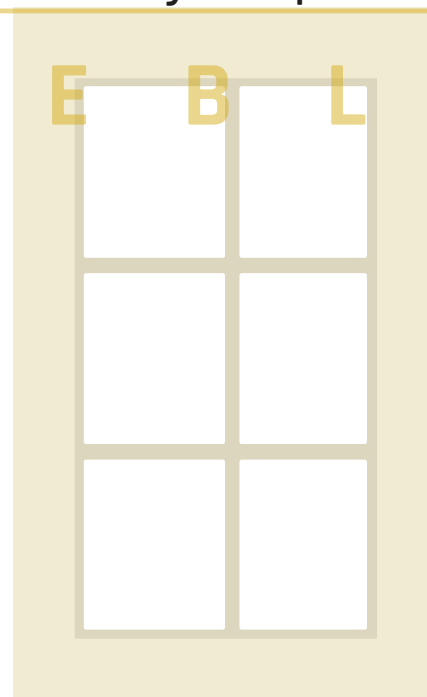

Witryna

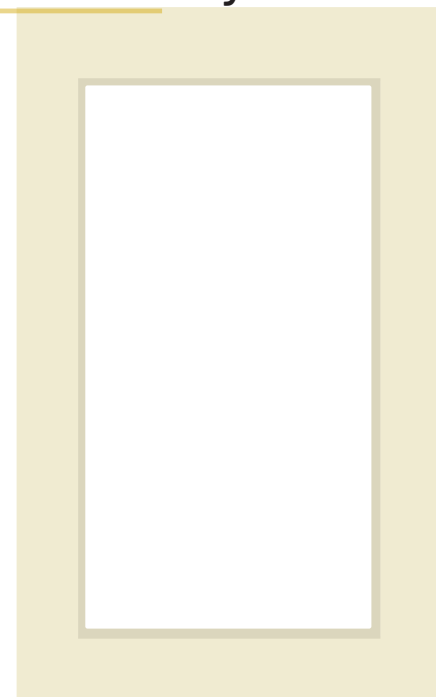

bd Bogdan Duraj

M E B L E

K4
Kaseton 4

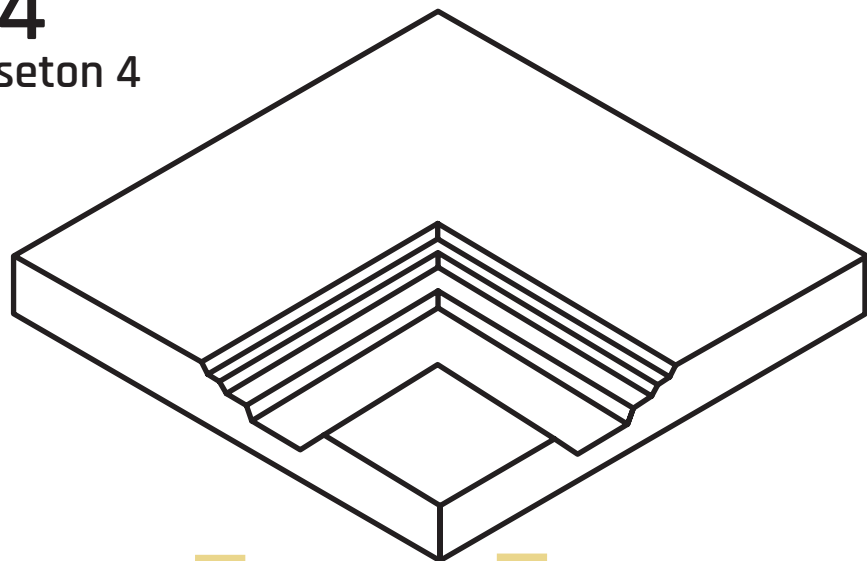

Front

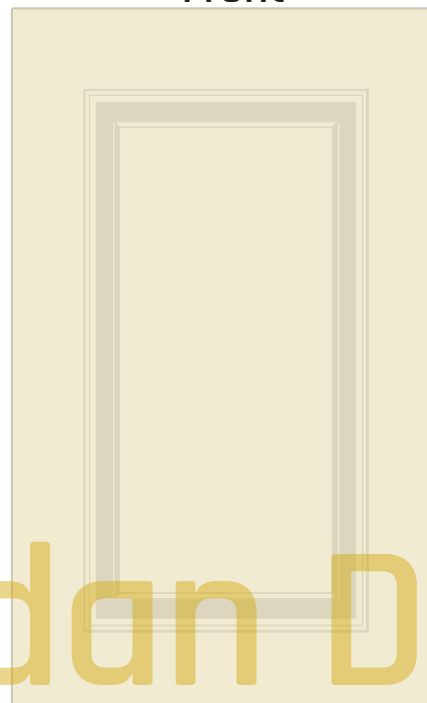

Szuflady

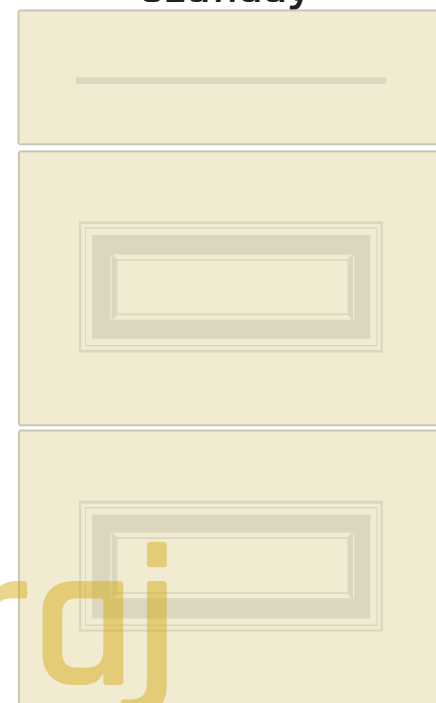

Witryna Szpros

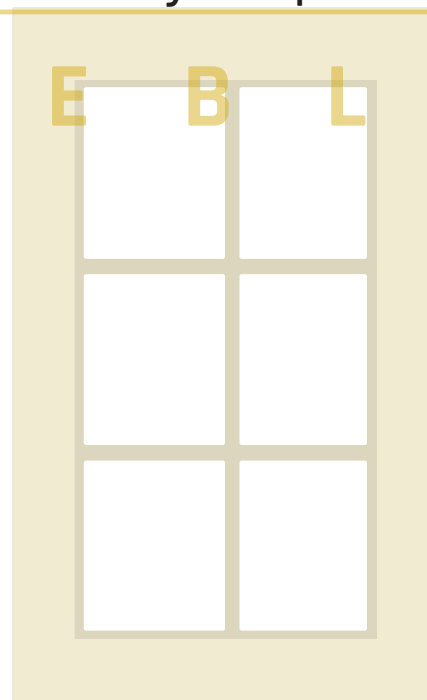

Witryna

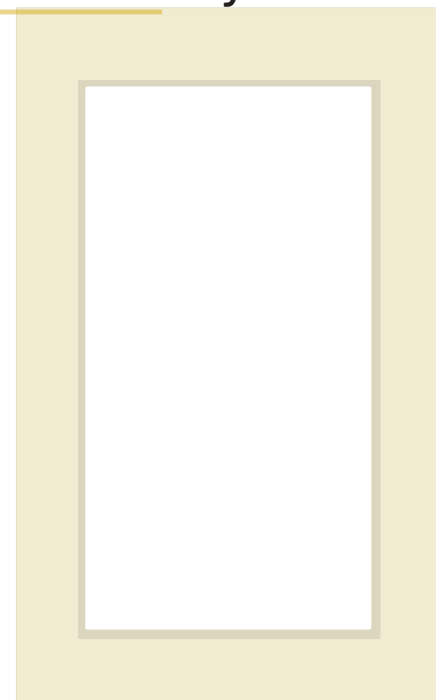

M E B L E

Bogdan Duraj

B

Blenda/Pilaster



50-70

B1



50-70

B2



50-70

B1



50-70

B1

W

Półka na wino



140-220



221-350



351-450

bd

Bogdan Duraj

M

E

B

L

E